

MACKIE

SRM350 2-WAY ACTIVE LOUDSPEAKER USER'S MANUAL

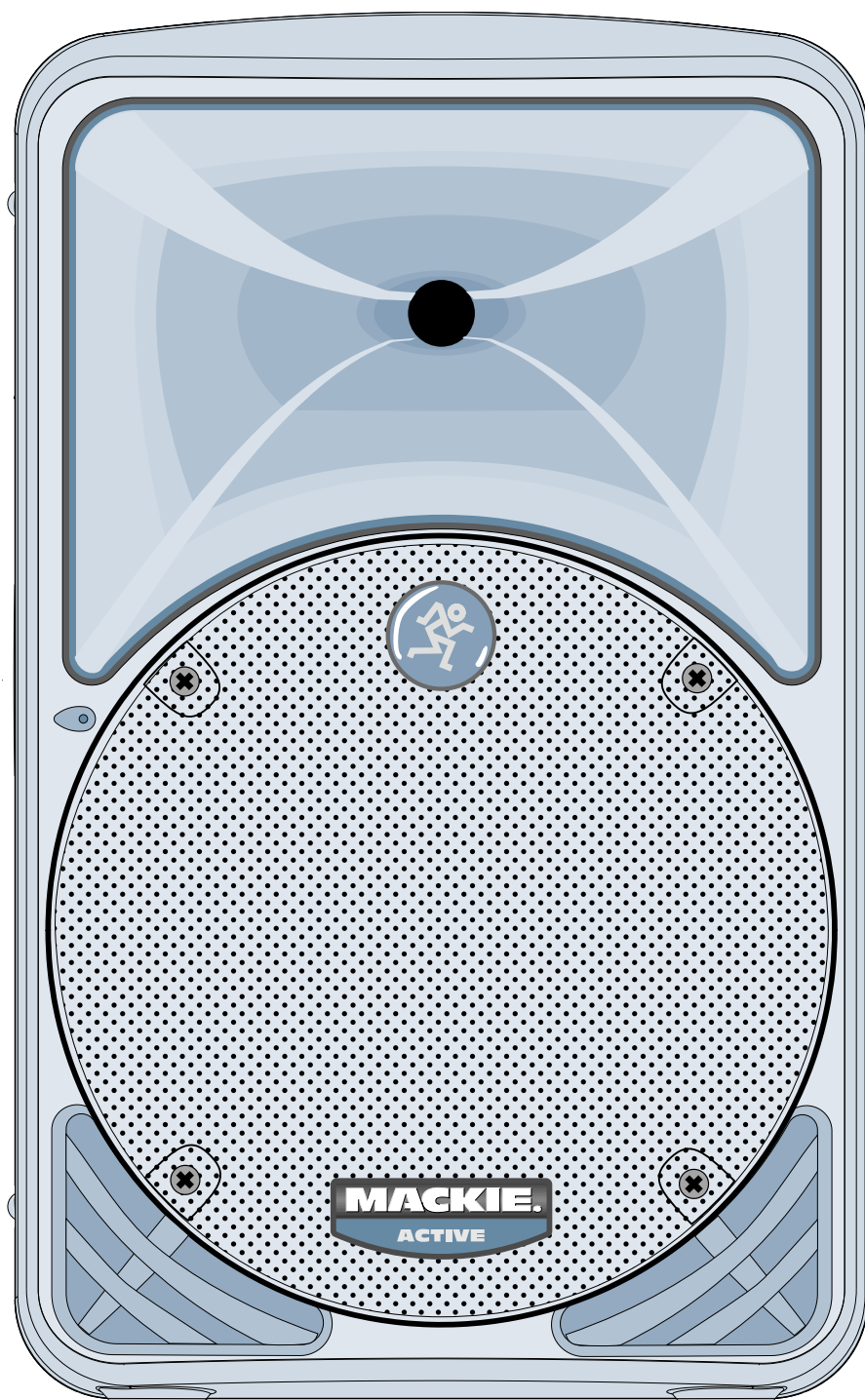

IMPORTANT SAFETY INSTRUCTIONS

1. Read these instructions.
2. Keep these instructions.
3. Heed all warnings.
4. Follow all instructions.
5. Do not use this apparatus near water.
6. Clean only with dry cloth.
7. Do not block any ventilation openings. Install in accordance with the manufacturer's instructions.
8. Do not install near any heat sources such as radiators, heat registers, stoves, or other apparatus (including amplifiers) that produce heat.
9. Do not defeat the safety purpose of the polarized or grounding-type plug. A polarized plug has two blades with one wider than the other. A grounding-type plug has two blades and a third grounding prong. The wide blade or the third prong are provided for your safety. If the provided plug does not fit into your outlet, consult an electrician for replacement of the obsolete outlet.
10. Protect the power cord from being walked on or pinched particularly at plugs, convenience receptacles, and the point where they exit from the apparatus.
11. Only use attachments/accessories specified by the manufacturer.
12. Use only with a cart, stand, tripod, bracket, or table specified by the manufacturer, or sold with the apparatus. When a cart is used, use caution when moving the cart/apparatus combination to avoid injury from tip-over.

PORTABLE CART WARNING



Carts and stands - The Component should be used only with a cart or stand that is recommended by the manufacturer. A Component and cart combination should be moved with care. Quick stops, excessive force, and uneven surfaces may cause the Component and cart combination to overturn.

13. Unplug this apparatus during lightning storms or when unused for long periods of time.

14. Refer all servicing to qualified service personnel. Servicing is required when the apparatus has been damaged in any way, such as power-supply cord or plug is damaged, liquid has been spilled or objects have fallen into the apparatus, the apparatus has been exposed to rain or moisture, does not operate normally, or has been dropped.

15. This apparatus shall not be exposed to dripping or splashing, and no object filled with liquids, such as vases, shall be placed on the apparatus.

16. This apparatus has been designed with Class-I construction and must be connected to a mains socket outlet with a protective earthing connection (the third grounding prong).

17. This apparatus has been equipped with an all-pole, rocker-style AC mains power switch. This switch is located on the rear panel and should remain readily accessible to the user.

18. This apparatus does not exceed the Class A/Class B (whichever is applicable) limits for radio noise emissions from digital apparatus as set out in the radio interference regulations of the Canadian Department of Communications.

ATTENTION — *Le présent appareil numérique n'émet pas de bruits radioélectriques dépassant les limites applicables aux appareils numériques de class A/de class B (selon le cas) prescrites dans le règlement sur le brouillage radioélectrique édicté par les ministere des communications du Canada.*

19. Exposure to extremely high noise levels may cause permanent hearing loss. Individuals vary considerably in susceptibility to noise-induced hearing loss, but nearly everyone will lose some hearing if exposed to sufficiently intense noise for a period of time. The U.S. Government's Occupational Safety and Health Administration (OSHA) has specified the permissible noise level exposures shown in the following chart.

<div style="display: inline-block; text-align: center;"> <p>CAUTION AVIS</p> <p>RISK OF ELECTRIC SHOCK DO NOT OPEN</p> <p>RISQUE DE CHOC ELECTRIQUE NE PAS OUVRIR</p> </div>
<p>CAUTION: TO REDUCE THE RISK OF ELECTRIC SHOCK DO NOT REMOVE COVER (OR BACK) NO USER-SERVICEABLE PARTS INSIDE REFER SERVICING TO QUALIFIED PERSONNEL</p> <p>ATTENTION: POUR EVITER LES RISQUES DE CHOC ELECTRIQUE, NE PAS ENLEVER LE COUVERCLE. AUCUN ENTRETIEN DE PIECES INTERIEURES PAR L'USAGER. CONFIEZ L'ENTRETIEN AU PERSONNEL QUALIFIE.</p> <p>AVIS: POUR EVITER LES RISQUES D'INCENDIE OU D'ELECTROCUTION, N'EXPOSEZ PAS CET ARTICLE A LA PLUIE OU A L'HUMIDITE</p>



The lightning flash with arrowhead symbol within an equilateral triangle is intended to alert the user to the presence of uninsulated "dangerous voltage" within the product's enclosure that may be of sufficient magnitude to constitute a risk of electric shock to persons.

Le symbole éclair avec point de flèche à l'intérieur d'un triangle équilatéral est utilisé pour alerter l'utilisateur de la présence à l'intérieur du coffret de "voltage dangereux" non isolé d'ampleur suffisante pour constituer un risque d'électrocution.



The exclamation point within an equilateral triangle is intended to alert the user of the presence of important operating and maintenance (servicing) instructions in the literature accompanying the appliance.

Le point d'exclamation à l'intérieur d'un triangle équilatéral est employé pour alerter les utilisateurs de la présence d'instructions importantes pour le fonctionnement et l'entretien (service) dans le livret d'instruction accompagnant l'appareil.

WARNING — To reduce the risk of fire or electric shock, do not expose this appliance to rain or moisture.



Lend Me Your Ears

Exposure to extremely high noise levels may cause permanent hearing loss. Individuals vary considerably in susceptibility to noise-induced hearing loss, but nearly everyone will lose some hearing if exposed to sufficiently intense noise for a period of time. The U.S. Government's Occupational Safety and Health Administration (OSHA) has specified the permissible noise level exposures shown in this chart.

According to OSHA, any exposure in excess of these permissible limits could result in some hearing loss. To ensure against potentially dangerous exposure to high sound-pressure levels, it is recommended that all persons exposed to equipment capable of producing these levels use hearing protectors while this unit is in operation. Ear plugs or protectors in the ear canals or over the ears must be worn when operating this amplification system in order to prevent a permanent hearing loss if exposure is in excess of the limits set forth here.

Duration Per Day In Hours	Sound Level dBA, Slow Response	Typical Example
8	90	Duo in small club
6	92	
4	95	Subway Train
3	97	
2	100	Very loud classical music
1.5	102	
1	105	Tami screaming at Adrian about deadlines
0.5	110	
0.25 or less	115	Loudest parts at a rock concert



The SRM350 can produce a maximum SPL of 121 dB @ 1m.

CONTENTS

IMPORTANT SAFETY INSTRUCTIONS	2	CONNECTIONS	10
INTRODUCTION	4	PLACEMENT	10
HOOKUP DIAGRAMS	6	THERMAL CONSIDERATIONS	12
Quick Start	6	AC POWER CONSIDERATIONS	12
REAR PANEL DESCRIPTION	8	SERVICE INFORMATION	14
1 IEC Socket	8	Warranty Service	14
2 POWER Switch	8	Troubleshooting	14
3 POWER Indicator	8	Repair	16
4 CONTOUR	8	CARE AND MAINTENANCE	16
5 LEVEL	8	SRM350 SPECIFICATIONS	17
6 MIC/LINE Switch	9	SRM350 BLOCK DIAGRAM	18
7 SIGNAL Indicator	9	SRM350 LIMITED WARRANTY	19
8 LIMIT Indicator	9		
9 INPUT Connector	9		
10 THRU Connector	9		
11 Accessory Plate	9		

Don't forget to visit our website at www.mackie.com for more information about these and other Mackie products.

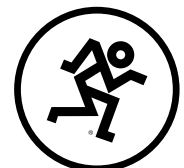

INTRODUCTION

Thank you for choosing LOUD Technologies' Mackie active sound reinforcement speakers.

The SRM350 is an active two-way loudspeaker capable of extremely high sound pressure levels, and designed to give you the best performance of any loudspeaker in its class and price range.

When we designed the SRM350s older sibling, the SRM450, our goal was to build a sound reinforcement speaker with the same fidelity and precision found in our renowned HR824 studio monitors. Apparently, people liked what they heard. Now, our goal for the SRM350 is to make the sound even better with improved active electronics, but delivered in a more compact size. We think you'll agree that the SRM350 sound quality and accuracy reaches this goal and more. The result is a compact sound reinforcement system equally at home in a concert setting, in the studio, impromptu concerts on the studio roof, in the cinema, or in a home theater.

The Transducers

The SRM350 active speakers feature a 10" high-power low-frequency woofer and a 1.4" titanium diaphragm high-output precision compression driver. This high-frequency driver is mounted on an acoustically non-resonant exponential waveguide, providing a wide, controlled dispersion and precise reproduction of the critical upper mid-range and high frequencies. The result is an unbelievably smooth off-axis response that allows everyone in the audience to experience the same high-resolution audio no matter where they are seated.

Each driver has been specifically designed by our engineers for optimum performance in the lightweight high-strength cabinet.

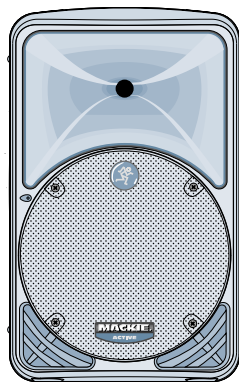

Power Amplifiers

To power these beautiful things, each SRM350 includes two power amplifiers. They include the following features:

- The low-frequency amplifier produces 165 continuous watts before clipping.
- The high-frequency amplifier produces 30 continuous watts before clipping.
- Both amplifiers are a Class H design, which uses a dual power supply for improved power and thermal efficiency. The amplifiers operate on the lower voltage rails until the signal requires more power, at which point the high voltage rails seamlessly kick in to provide additional power.
- An Active Protection Management System monitors the output levels from both amplifiers as well as the operating temperature of the amplifiers. When the output from either amplifier begins to clip, a limiter gently reduces the input signal level until the output is no longer clipping. Likewise, if the temperature of either of the amplifiers begins to exceed a safe operating level, the input signal is elegantly adjusted to keep the temperature at a desired operating level.
- The low-frequency amplifier also has a Dynamic Bass Boost circuit. Our ears are more sensitive to bass frequencies at high volume levels than at softer volumes. This unique circuit automatically reduces the low frequencies below 70 Hz as the volume of the speakers goes up. This results in improved efficiency for the low-frequency amplifier because it is not wasting power trying to reproduce frequencies we hear better at loud volumes. Instead, the power is used for the frequencies where it is needed, resulting in a louder sound.

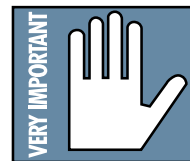

Warning: Although the amplifiers have these protection circuits, you must still make sure the LIMIT light is not blinking continuously. If it is, turn down your mixer faders, or preamplifier gain, or turn down the SRM350 LEVEL control.

The Crossover

The built-in electronic crossover is a 24 dB/octave Linkwitz-Riley design. Although more expensive than other crossover designs, the benefits provided by the Linkwitz-Riley design have been well documented. These benefits include:

- Absolutely flat frequency response throughout the bandpass, without the characteristic ripple near the crossover point exhibited by other designs.
- The sharp 24 dB per octave roll-off of the filters ensures that the transducers aren't reproducing frequencies outside of their capabilities.
- The acoustic sum of the two driver responses is unity at the crossover frequency, resulting in perfect power response.
- Our heroic engineers have worked carefully to ensure that the SRM350 also provides perfect phase response. This diligence has yielded phenomenal accuracy, even if you are standing 20 feet away.

The Cabinet

The SRM350 cabinet was designed to be the strongest molded composite cabinet on the planet. This material is as strong as concrete, and rigid enough to prevent unwanted vibrations in the cabinet. An optional bracket kit is available for the top and bottom of the cabinet to be used for flying, and a socket is provided in the bottom of the cabinet for mounting on a tripod stand. Although it is an exceptional choice for installed sound situations, its light weight and durable finish also make it ideal for portable sound system use. The asymmetrical trapezoidal design of the cabinet makes it easy to use as a floor wedge for stage monitor applications.

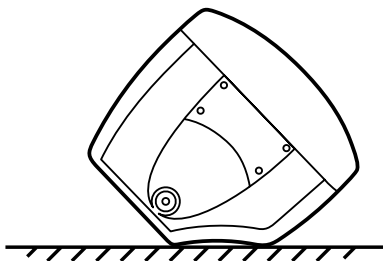

The Active Advantage

There are a number of advantages to using an active speaker system over a passive loudspeaker:

- The internal crossover is active, and its low power circuitry operates on line-level signals. It does not waste speaker-level power like a passive crossover with large coils, caps, and resistors.
- The input signals are crossed over before they reach the amplifiers, so each amplifier only receives the correct frequency range for its driver.
- The amplifiers are designed specifically for these speaker load impedances. There is no guesswork as to what load each amplifier has to drive, so they can provide maximum acoustic output from the speakers, yet minimize the danger of speaker damage due to overdriving a lesser amplifier.
- The connecting wires between the amplifier outputs and the drivers are kept to a minimum, so the damping factor of the amplifier isn't compromised by the resistance of long speaker cables. In addition, all the power from the amplifier is transferred directly to the drivers with no speaker cable losses.
- The acoustic sum of the outputs from the two drivers is optimized electronically, as well as physically, so the amplitude response is flat and there is no lobing error.
- The presence of active circuits within the speaker cabinet allow the designer to add on extra details, such as a high quality mic/line input section and optional accessory modules.

In short, all the complex interconnected components in the system are designed to work in harmony with each other to produce the best possible sound.

HOOKUP DIAGRAMS

Quick Start

1. Start with the following settings on the back of the SRM350:
Turn the **POWER** switch off (down).
Set the **CONTOUR** and **MIC/LINE** switches out. If using a microphone as the input to the SRM350, push the **MIC/LINE** switch in.
2. Connect the output from your signal source (mixing console, microphone, preamp, or other mic- or line-level source) directly to the **INPUT** connector on the back of the SRM350. This is a combination XLR and 1/4" TRS connector, and accepts balanced or unbalanced line-level signals from mixers, preamplifiers, CD players, tape decks, etc., with the **MIC/LINE** switch



WARNING: Turn the **LEVEL** control down (counterclockwise) before every use. If not, you could be in for a startling surprise, especially if the last time you used it was with a microphone and now you want to connect a line-level source.

out, and accepts direct connections from dynamic microphones with the **MIC/LINE** switch pushed in.

3. Connect the supplied AC power cord to the IEC socket on the back of the SRM350. Plug the other end into an AC outlet properly configured with the correct voltage for your particular model.
4. Turn on your signal source. Make sure its Master Volume control (if it has one) is turned all the way down.
5. Turn on the SRM350 **POWER** switch.
6. Start the signal source, whether it be speaking into a microphone or starting a CD player. Adjust any volume controls on the signal source for normal operation.
7. Slowly turn up the **LEVEL** control on the back of the SRM350 until the desired volume is reached (and the **LIMIT** light does not come on). **Always** wear hearing protectors if you are close when it is playing at high levels.
8. If there is no sound, **always** turn down the SRM350 **LEVEL** control before investigating. There may be a mixer or preamplifier mute or tape switch engaged, or a mic switch off.

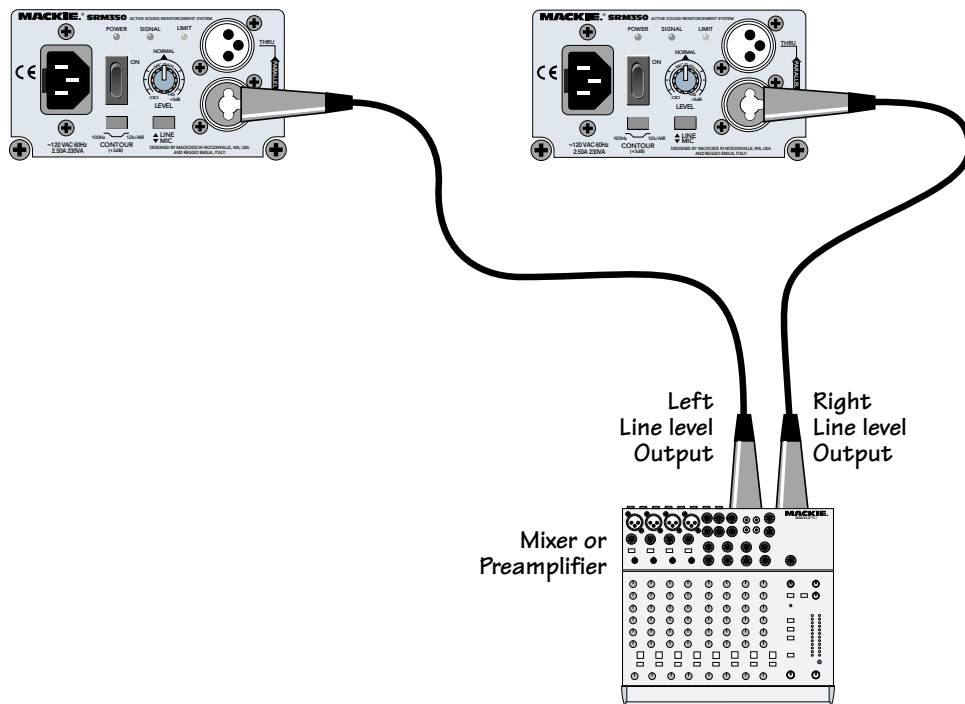

SRM350: STEREO OPERATION WITH A MIXER

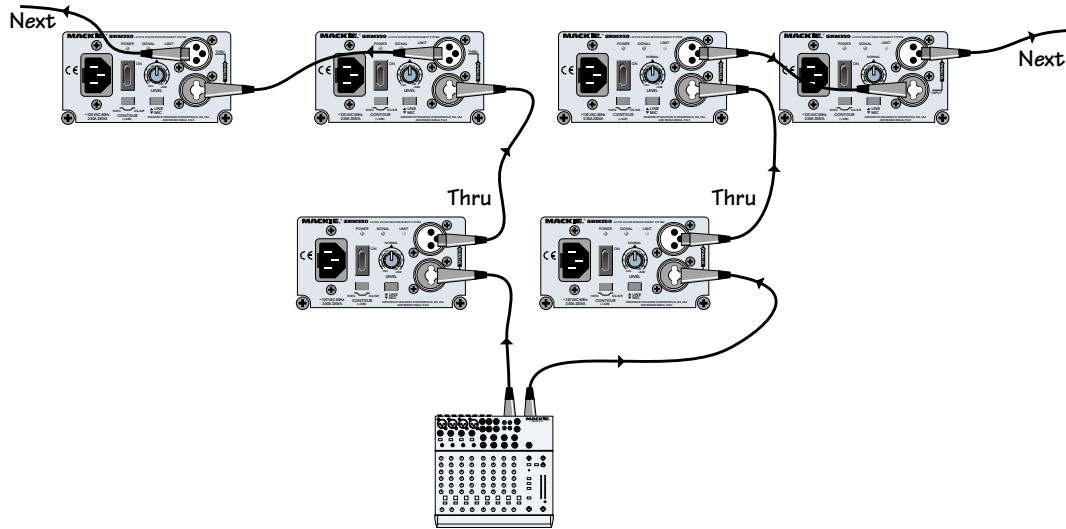

SRM350: DAISY-CHAINING USING THE THRU JACK

The SRM350 can be used with a Mackie SWA1501 or SWA1801 subwoofer to create an incredibly powerful system.

The active crossover inside the subwoofer splits the full range input signal into two ranges. The subwoofer plays the low frequency range through its built-in amplifier and woofer, and sends the high-pass range to the SRM350.

The SRM350 can be pole mounted on top of the SWA1501 or 1801 as shown.

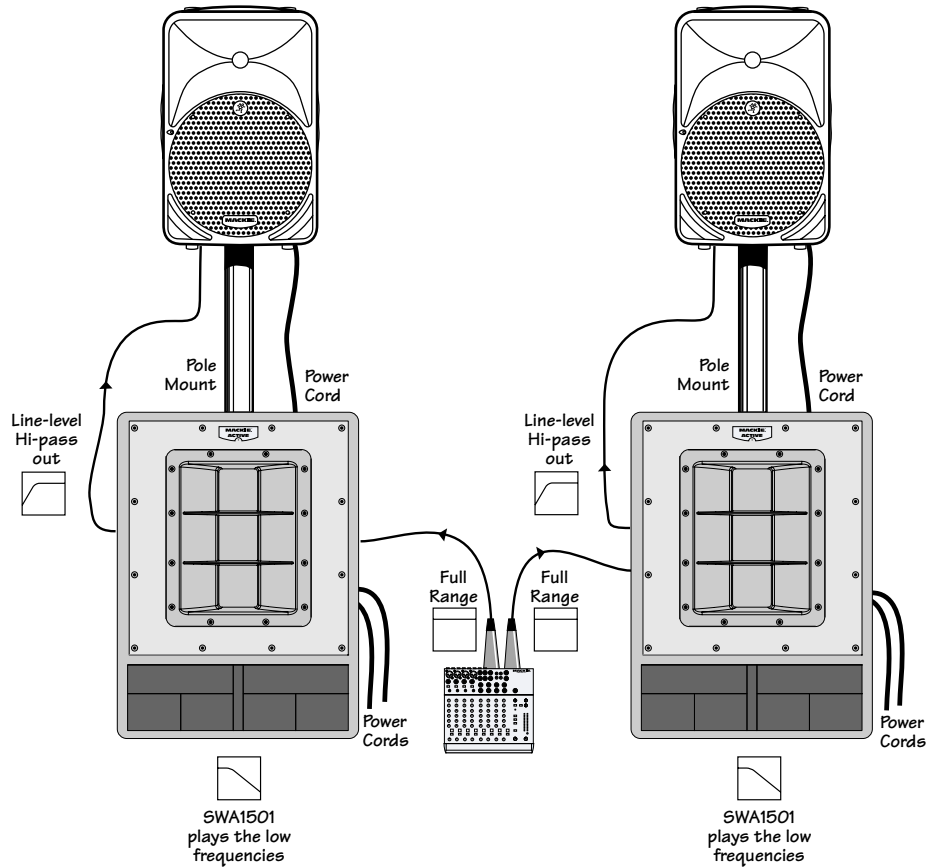

SRM350: BIAMPING WITH A POWERED SUBWOOFER

REAR PANEL DESCRIPTION

The SRM350 has several connectors, controls, and indicators that you should understand.

1 IEC Socket

This is where you connect the supplied AC linecord to provide AC power to the SRM350's built-in power amplifiers. Plug the linecord into an AC socket properly configured for your particular model.

Note: If you happen to lose the AC linecord, replacements are readily available at any office or computer supply store. Always use a three-pin plug with a ground pin.

2 POWER Switch

Switch up to turn the SRM350 on, and switch down to turn it off. Make sure the LEVEL control is down before you turn it on.

3 POWER Indicator

When the POWER switch is turned on, and the linecord is connected to an active AC Mains supply, this indicator, located just above the POWER switch, glows to let you know that you're ready to rock and roll. The cool blue LED on the front of the speaker works in the same way.

4 CONTOUR

Pushing in this switch engages a filter that provides 3 dB of boost to the low and high frequencies (below 100 Hz and above 12 kHz). This provides a punchy, crisp sound for most live music applications. You can experiment with this switch by leaving it out for a while, then pushing it in to determine which way sounds best for your application. It is especially useful when listening at lower volumes, as it highlights the bass like a Loudness switch, in addition to boosting the highs.

5 LEVEL

This is used to adjust the signal level, going into the built-in power amplifiers, from Off up to 45 dB of gain. Since the SRM350 incorporates Mackie's world-class low-noise mic preamp technology, you can connect either a line-level or a microphone-level signal to the input, and use this control to adjust the level correctly.



There is no phantom power for a microphone, so you should use a dynamic mic, or use a condenser type if it has its own battery power.

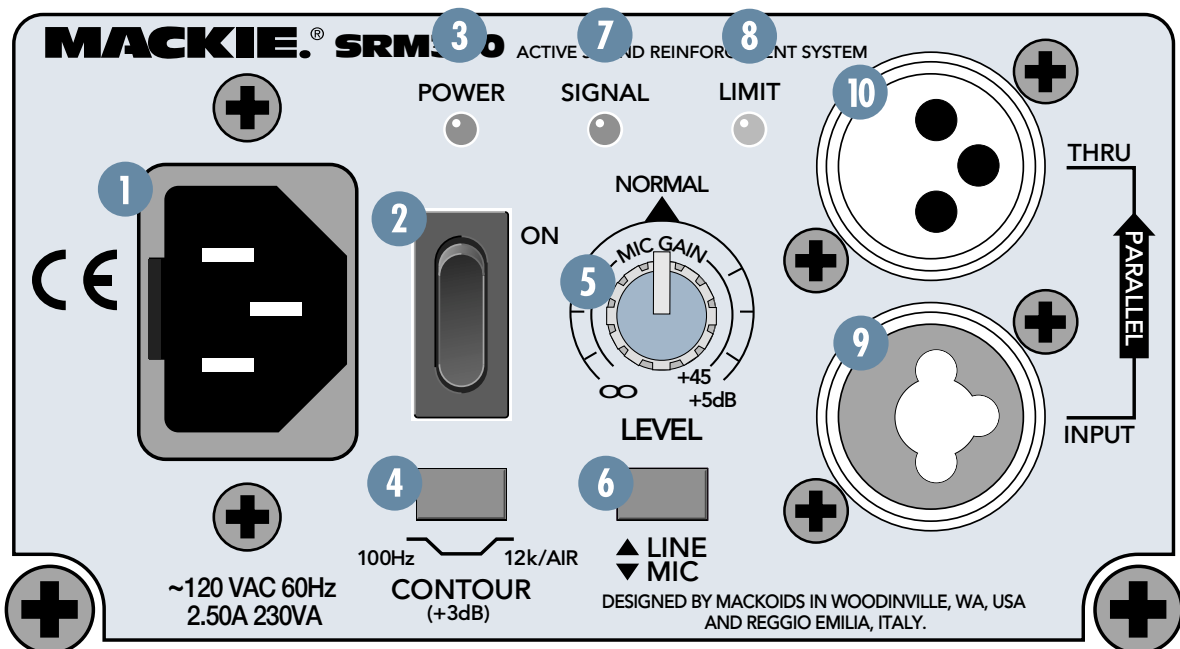

Follow the Quick Start guide on page 6 for setting the **LEVEL** control. For most applications, it will be in the **NORMAL** position (12 o'clock) . If you have a particularly high line-level signal connected to the SRM350, you may need to turn the control down to the 9 o'clock position. If you have a low line-level or mic-level signal connected, you may need to turn the **LEVEL** control up to the 3 o'clock position.

6 MIC/LINE Switch

Leave this switch out when connecting a line-level signal to the **INPUT** connector (from a mixer, graphic EQ, or other line-level signal source).

Push this switch in when connecting a microphone to the **INPUT** connector. Since a microphone produces a much smaller signal than a line-level signal, this provides an additional 40 dB of gain to boost the microphone signal to a line level.

7 SIGNAL Indicator

This LED illuminates whenever there is a signal present at the **INPUT** connector on the rear panel. It senses the signal just after the **LEVEL** control, so if the **LEVEL** control is turned down, the **SIGNAL** indicator won't light.

8 LIMIT Indicator

When the signal levels at the amplifier outputs approach clipping, a soft limiting circuit is activated that reduces the input signal. The **LIMIT** LED lights whenever the limit circuit is active.

It's okay for the **LIMIT** indicator to blink occasionally, but if it blinks frequently or continuously, either turn down the signal level at the mixer or other signal source, or turn down the SRM350's **LEVEL** control.



Wear hearing protection if you are close to the SRM350 playing at high levels.

9 INPUT Connector

This is a combination female XLR-type and 1/4" TRS connector that accepts a balanced or unbalanced mic- or line-level signal.

10 THRU Connector

This is a male XLR-type connector that can be used to daisy-chain the input signal to another speaker.

The signal at this point is after the **MIC/LINE** switch but before the **LEVEL** control. If you have a microphone connected to the first SRM350 and you have the **MIC/LINE** switch pushed in, the signal at the **THRU** jack is boosted 40 dB to a line-level, so leave the **MIC/LINE** switch out on the next SRM350.

11 ACCESSORY Plate

This removable plate provides access to install future accessory modules.

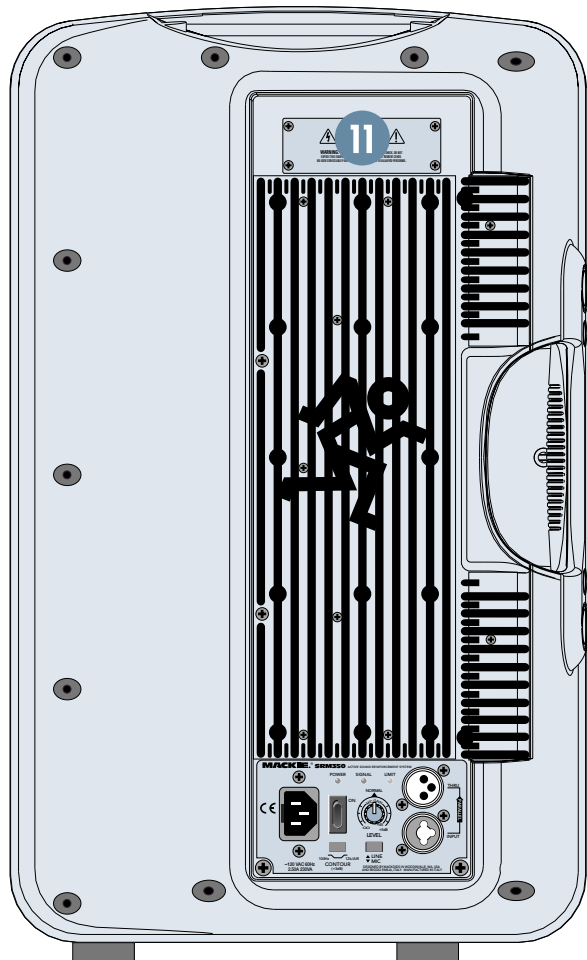

CONNECTIONS

The SRM350 has a combination female XLR and 1/4" TRS input that accepts a balanced or unbalanced mic- or line-level signal. When connecting a balanced signal, be sure it's wired per AES (Audio Engineering Society) standards:

	XLR	TRS
Hot (+)	Pin 2	Tip
Cold (-)	Pin 3	Ring
Shield (Ground)	Pin 1	Shield

There is also a male XLR connector labeled **THRU**. This allows you to connect more than one SRM350 to the output of your mixing console. Simply plug the signal source output into the first **INPUT** jack, and patch that speaker's **THRU** jack to the next **INPUT** jack, and so on, daisy-chaining multiple speakers (see diagram on page 7).



The **THRU** jack's signal comes after the **MIC/LINE** switch, but before the **LEVEL** control. If the **MIC/LINE** switch is pushed in on the first SRM350, the signal at the **THRU** jack is boosted by 40 dB to a line level. Therefore, leave the **MIC/LINE** switch out on the following SRM350s in the chain.

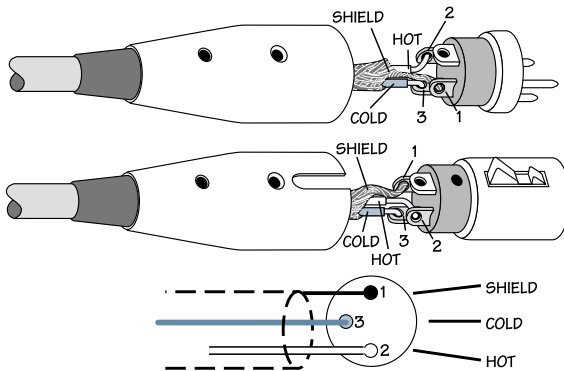

Balanced XLR Connectors

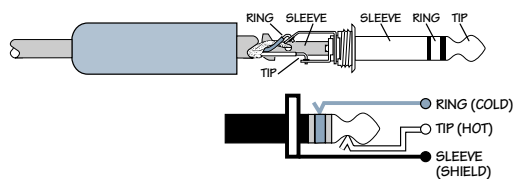

Balanced TRS Connectors

PLACEMENT

The SRM350 active speakers are designed to sit on the floor, a tabletop, or to fit on a standard tripod speaker stand. They can also be suspended by the rigging points, which requires installing the optional hanging bracket on the top and/or bottom of the cabinet. **NEVER** attempt to suspend the SRM350 active speakers by their handles.

You can lay the cabinet down on its side and use the SRM350 as a floor monitor. The asymmetrical trapezoidal shape of the cabinet provides a perfect angle for aiming up toward performers from the front of the stage.

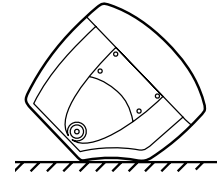

As with any powered components, protect them from moisture. If you are setting them up outdoors, make sure they are under cover if you expect rain.



The SRM350 generates magnetic fields. Place it at least two feet (0.6 meters) or more from computer monitors.

Check the screen for any change in color or distortion. Do not place any magnetic audio or video tapes or computer discs near the SRM350s.

Room Acoustics

The SRM350 active speakers are designed to sound as neutral as possible; that is, to reproduce the input signal as accurately as possible, *monitoring* the sound rather than changing it.

Room acoustics play a crucial role in the overall performance of a sound system. However, the wide high-frequency dispersion of the SRM350 helps to minimize the problems that typically arise.

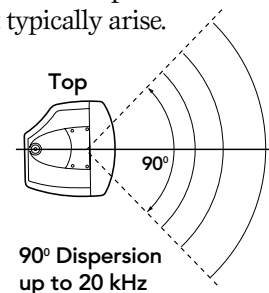

Here are some useful placement tips:

- Avoid placing loudspeakers in the corners of a room. This increases the low-frequency output and can cause the sound to be muddy and indistinct.
- Avoid placing loudspeakers against a wall. This, too, increases the low-frequency output, though not as much as corner placement. However, if you do need to reinforce the low frequencies, this is a good way to do it.
- Avoid placing the active speakers directly on a hollow stage floor. A hollow stage can resonate at certain frequencies, causing peaks and dips in the frequency response of the room. It's better to place the active speakers on a sturdy table or tripod stands.
- Position the active speakers so the high-frequency drivers are 2 to 4 feet above ear level for the audience (make allowances for a standing/dancing in the aisles audience). High frequencies are highly directional and tend to be absorbed much easier than lower frequencies. By providing direct line-of-sight from the active speakers to the audience, you increase the overall brightness and intelligibility of the sound system.
- Highly reverberant rooms, like many gymnasiums and auditoriums, are a nightmare for sound system intelligibility. Multiple reflections off the hard walls, ceiling, and floor play havoc with the sound. Depending on the situation, you may be able to take some steps to minimize the reflections, such as putting carpeting on the floors, closing draperies to cover large glass windows, or hanging tapestries or other materials on the walls to absorb some of the sound.

However, in most cases, these remedies are not possible or practical. So what do you do? Making the sound system louder generally doesn't work because the reflections become louder, too. The best approach is to provide as much direct sound coverage to the audience as possible. The farther away you are from the speaker, the more prominent will be the reflected sound.

Use more speakers strategically placed so they are closer to the back of the audience. If the distance between the front and back speakers is more than about 100 feet, you should use a delay processor to time-align the sound. (Since sound travels about 1 foot per millisecond, it takes about 1/10 of a second to travel 100 feet).

RIGGING

The SRM350 cabinets are fitted with four M5 insert points on the top and bottom for installing an optional hanging bracket that allows the speaker to be flown. **SRM350 Bracket Kit: Part No. 0016404**



WARNING: Never attempt to suspend the SRM350 active speakers by their handles. If you want to suspend them, use the hanging brackets only.

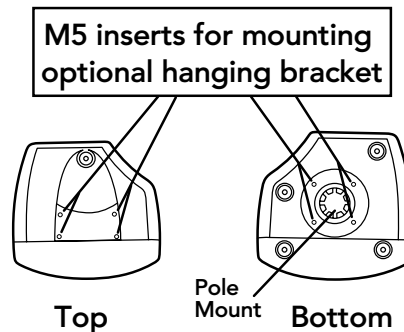

If you are hanging them in an inaccessible place, such as over a lion's cage, make sure that you first complete the sound check and set the SRM350 LEVEL correctly.

THERMAL CONSIDERATIONS



The amplifiers inside the SRM350 are convection cooled by a large heatsink. For efficient cooling, it is important to allow at least six inches of free space behind the SRM350.

If the ambient temperature in the room is high, it could cause the amplifiers to overheat. In this case, you should try aiming a fan at the heatsink to increase the air flow through the fins.

During a performance, don't have it cranked so high that the rear panel **LIMIT** LED is blinking frequently or lighting continuously. You should turn down the **LEVEL** control a notch or two to avoid overheating the amplifiers or your neighbors.

If the amplifiers begin to overheat, the Active Protection Management System gently reduces the input signal level until the amplifiers have cooled down to a safe operating temperature.

AC POWER CONSIDERATIONS

Be sure the SRM350 is plugged into an outlet that is able to supply the correct voltage specified for your model. If the voltage should drop below 97 % of the specified line voltage, the built-in amplifiers will no longer be able to supply rated power. (They will continue to operate down to 75 % of the rated line voltage, but won't reach full power, resulting in lower headroom.)

Under maximum SPL conditions, where musical peaks are clipping, the SRM350 120V model draws 2.5 amps on average (1.3 amps for the 230V model). Under normal conditions, the current draw is below 1 amp.

We recommend that a stiff (robust) supply of AC power be used because the amplifiers place high current demands on the AC line. The more power that is available on the line, the louder the speakers will play and the more peak output power will be available for cleaner, punchier bass. A suspected problem of "poor bass performance" is often caused by a weak AC supply to the amplifiers.

AC Power Distribution

A 240VAC center-tapped service entrance transformer serves the majority of AC outlets encountered in homes and clubs (in the U.S.). This provides two phases of AC power on either side of the center tap, at 120V each.

If lighting is used in a show, it is preferable to power the lights from one leg of the service, and power the audio equipment from the other leg. This will help minimize noise from the lights coupling into the audio (particularly if SCRs, or light-dimmer switches, are used).

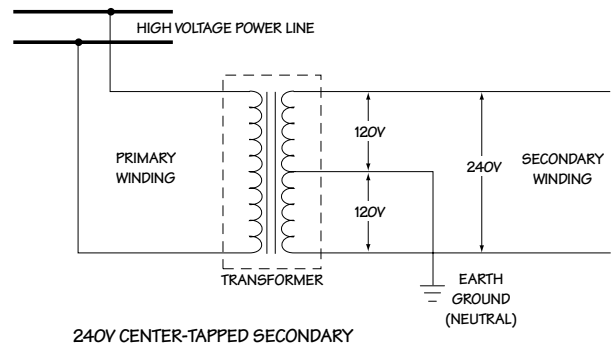

Wherever possible, connect all of your equipment to the same electrical circuit. This will help reduce the possibility of a ground loop problem causing an annoying hum in your speakers.

Low power components such as tape decks, mixers, effects processors and CD players should be connected to the same outlet as the SRM350s. Use fused power strips as shown in the diagram below. Make sure that the total current draw of your components does not exceed the capability of the outlets and power strips.

For the US 120 V model:
 A maximum of five SRM350s can be connected per 15A service.
 This allows each SRM350 to be safely operated at its maximum level.

When turning your system on, turn on the SRM350s last. This will stop any turn-on thumps and bangs from your source equipment being amplified.

When turning off your system, turn off the SRM350s first. This will prevent any turn-off thumps and bangs from your source equipment being amplified.



When setting up for a show, often you are plugging into an AC power distribution system you know nothing about. You may even be faced with

2-wire outlets that are missing the third safety ground pin. It's a good idea to have a three-wire AC outlet tester in your toolbox so you can check the outlets yourself to make sure they are wired correctly. These testers will tell you if the polarity of the hot and neutral wires is reversed and if the safety ground is disconnected.



Don't use an outlet if it is wired improperly! This is to protect yourself as well as your equipment.



Never remove the ground pin on the power cord of the SRM350 or any other component. This is very dangerous.

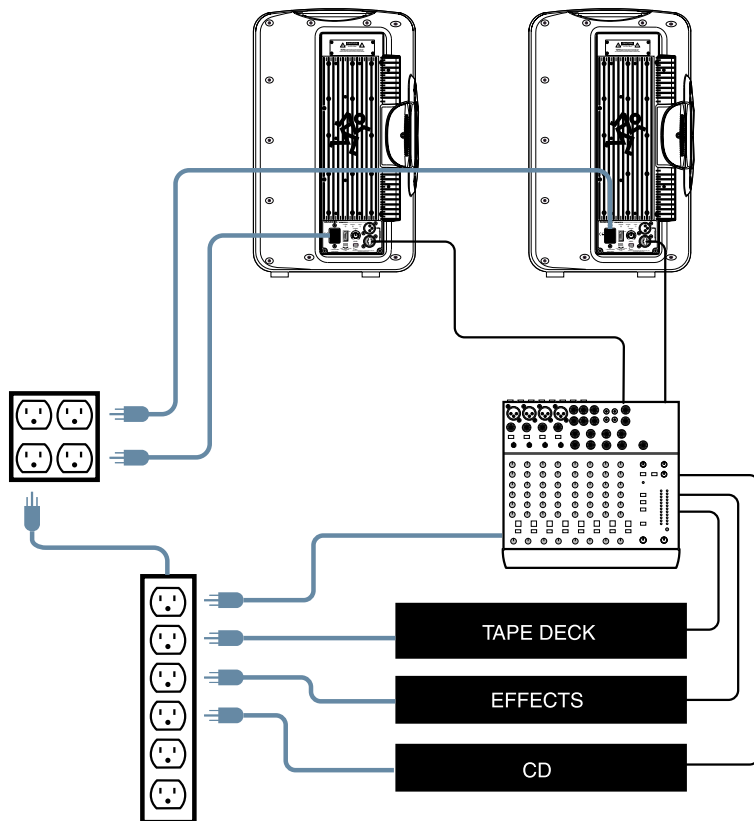

SRM350: AC CONNECTIONS

SERVICE INFORMATION

Warranty Service

Details concerning Warranty Service are spelled out on page 19 of this manual.

If you think your loudspeaker has a problem, please do everything you can to confirm it before calling for service, including reading through the following troubleshooting section. Doing so might save you from being deprived of your Mackie loudspeaker.



If you do find the problem, make sure that you turn down the **LEVEL** controls and turn off the SRM350 before correcting it or changing any connections.

Of all Mackie products returned for service (which is hardly any at all), many are coded “CND” — Could Not Duplicate— which usually means the problem lay somewhere else in the system. The following troubleshooting tips may sound obvious, but here are some things you can check:

Troubleshooting

No power!

- Our favorite question: Is it plugged in? Make sure the AC outlet is live (check with a tester or lamp).
- Our next favorite question: Is the **POWER** switch on? If not, try turning it on.
- Is the blue light on the front panel illuminated? If not, make sure the AC outlet is live. If so, refer to “No sound” below.
- The AC line fuse inside the chassis is blown. This is not a user-serviceable part. Refer to “Repair” on page 16 to find out how to proceed.

No sound!

- Is the input **LEVEL** control turned all the way down? Follow the procedures in the “Quick Start” section on page 6 to verify that all the volume controls in the system are properly adjusted.
- Is the signal source working (and making union scale)? Make sure the connecting cables are in good repair and securely connected at both ends. Make sure the output volume (gain) control on the mixing console or preamp is turned up sufficiently to drive the inputs of the speaker. You should be able to see the **SIGNAL LED** blink on the rear panel.
- Make sure the preamp or mixer does not have a Mute on, or a Tape or Processor loop engaged. If you find something like this, make sure the volume/gain is turned down before disengaging the offending switch.

One side is way louder than the other!

- Are the **LEVEL** controls set the same on both active speakers?
- Check the **PAN** control or balance on the signal source. It may be turned too far to one side. If you’re using a stereo signal source, it may be delivering an out-of-balance stereo signal.
- Try swapping sides: Turn off the active speakers, swap the input cables coming from the mixing console, turn the active speakers back on. If the same side is still louder, the problem may be with your active speakers or cables between the mixer and the active speaker. If the other side is louder now, the problem is with the mixer or the signal source.

Poor bass performance

- Check the polarity of the connections between the mixer/preamp and the active speakers. You may have your positive and negative connections reversed at one end of one cable, causing one SRM350 to be out-of-phase.

Bad sound!

- Is it loud and distorted? Follow the procedures described in the “Quick Start” section to verify that the levels are set properly.
- Is the input connector plugged completely into the jack? Be sure all connections are secure. It’s a good idea to periodically clean all electrical connections with a non-lubricating electrical contact cleaner.

Noise

- Make sure all connections to the active speakers are good.
- Make sure none of the signal cables are routed near AC cables, power transformers, or other EMI-inducing devices.
- Is there a light dimmer or other SCR-based device on the same AC circuit as the SRM350? Use an AC line filter or plug the SRM350 into a different AC circuit.

Hum

- Turn the LEVEL control all the way down. If the noise disappears, it’s coming from the signal source. If not, try disconnecting the cable connected to the INPUT jack. If the noise disappears, it could be a “ground loop,” rather than a problem with the SRM350. Try some of the following troubleshooting ideas:
- Use balanced connections throughout your system for the best noise rejection.
- Whenever possible, plug all the audio equipment’s linecords into outlets which share a common ground (see the diagram on page 13). The distance between the outlets and the common ground should be as short as possible.



Never remove the ground pin on the power cord of the SRM350 or any other component. This is very dangerous.

- The hum may appear when using an unbalanced source (consumer preamp, CD player, VCR, etc.). This is caused by the unbalanced-to-balanced interface between the devices (and exacerbated by the fact that most consumer audio equipment have a two-wire linecord, without the third-pin safety ground).

Use an interconnect cable wired as shown below. The important point is that the shield and the wire from the XLR pin 3 are joined at the RCA (source) end.

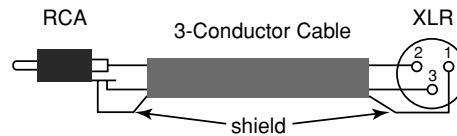

- Disconnect any cables which come in from outside, such as cable TV, satellite TV or roof top antennas. They must be disconnected from *every* part of your system, such as the TV, VCR and preamp. If the hum goes away, you can add a “ground loop isolator” in your cable line. This is an inexpensive device available from video or TV dealers, or you can make your own from two TV baluns (standard TV 75/300 ohm adaptors):

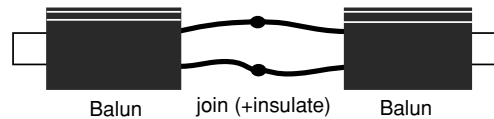

The baluns are threaded at one end (75 ohm) to fit TV coax cable and have two wires at the other end (300 ohm). They will not affect the video quality.

- If the hum persists, try removing components one at a time from the back of the mixer or preamplifier, and check for hum each time (turn off your equipment before you undo any connections). It is fairly common to find more than one problem.
- If your preamp or mixer are the only things connected to the SRM350s and the hum is still there, try different connection cables, or move the preamp/mixer to another location.

Repair

Service for Mackie products is available at a factory-authorized service center. Service for Mackie products living outside the United States can be obtained through local dealers or distributors.

If your SRM350 needs service, please follow these instructions:

1. Review the preceding troubleshooting suggestions. Please.
2. Call Tech Support at 1-800-898-3211, 8am to 5pm PST, to explain the problem in detail. If it appears that the SRM350 needs repair, you will be given a Service Request Number. Have your loudspeaker's serial number ready. *You must have an Service Request Number before you can obtain service at a factory-authorized service center.*
3. Keep this user's manual and the detachable linecord. We don't need them to repair the loudspeaker.
4. *Pack the loudspeaker in its original package*, including endcaps and box. **This is VERY IMPORTANT.** When you call for the Service Request Number, please let Tech Support know if you need new packaging. *Mackie is not responsible for any damage that occurs due to non-factory packaging.*
5. Include a legible note stating your name, shipping address (no P.O. boxes), daytime phone number, Service Request Number, and a detailed description of the problem, including how we can duplicate it.
6. Write the Service Request Number in **BIG PRINT** on top of the box. Product shipped without the Service Request Number will be refused.
7. Tech Support will tell you where to ship the loudspeaker for repair. We suggest insurance for all forms of cartage.



8. We'll try to fix the loudspeaker within five business days. Once it is repaired, we'll ship it back the same way in which it was received. This paragraph does not necessarily apply to non-warranty service.

Note: Under the terms of the warranty, you must ship or drop-off the unit to an authorized service center. The return ground shipment is covered for those deemed by us to be under warranty.

Note: You must have a sales receipt from an Authorized Mackie Dealer to qualify for a warranty repair.

CARE AND MAINTENANCE

Your Mackie active speakers will provide many years of reliable service if you follow these guidelines:



Avoid exposing the active speakers to moisture. If they are set up outdoors, be sure they are under cover if you expect rain or you live in Washington.

- Avoid exposure to extreme cold (below freezing temperatures). If you must operate the active speakers in a cold environment, warm up the voice coils slowly by sending a low-level signal through them for about 15 minutes prior to high-power operation.
- Use a slightly damp cloth with a mild soap solution to clean the cabinets. Only do this when the power is turned off. Avoid getting moisture into any of the openings of the cabinet, particularly where the drivers are located.

Need Help?

You can reach a technical support representative

Monday through Friday

from 7 AM to 5 PM PST at:

1-800-898-3211

After hours, visit www.mackie.com and click Support,

or email us at: techmail@mackie.com

SRM350 SPECIFICATIONS

System Specifications

<i>Frequency Response (-3 dB)</i>	83 Hz - 18.5 kHz
<i>Frequency Range (-10 dB)</i>	61 Hz - 22 kHz
<i>Max SPL Long-Term @ 1m</i>	118 dB
<i>Max SPL Peak @ 1m</i>	121 dB
<i>Crossover</i>	Linkwitz-Riley 24 dB/octave @ 2400 Hz

Audio

<i>Input Type</i>	Balanced Differential
<i>Input Impedance</i>	94k ohms
<i>Sensitivity (center detent)</i>	Line: +4 dBu Mic: -36 dBu
<i>Maximum Input Level</i>	+22 dBu
<i>Acoustic Contour Equalization (peaking)</i>	+3 dB @ 100 Hz, +3 dB @ 12 kHz
<i>Accessory Interface</i>	± 15 VDC, normalized signal I/O
<i>Operating Temperature Range</i>	-10°C - 45°C (14°F - 113°F)

Power Amplifiers

Low-Frequency Power Amplifier

<i>Rated Power</i>	165 watts continuous*
<i>Rated THD</i>	< 0.03%
<i>Cooling Design</i>	Convection Extrusion Class H

High-Frequency Power Amplifier

<i>Rated Power</i>	30 watts continuous*
<i>Rated THD</i>	< 0.03%
<i>Cooling Design</i>	Convection Extrusion Class H

* Rated power is continuous rms wattage into transducer's rated impedance @ 1 kHz for the HF amplifier and @ 100 Hz for the LF amplifier.

Transducer Specifications

Low-Frequency Transducer

<i>Diameter</i>	10 in/250 mm
<i>Voice Coil Diameter</i>	2.0 in/51 mm
<i>Sensitivity (1W@1m)</i>	96 dB
<i>Power Handling</i>	250 watts rms, long-term
<i>Frequency Range</i>	61 Hz - 3 kHz
<i>Magnet Type</i>	Ferrite

High-Frequency Transducer

<i>Diaphragm Diameter</i>	1.4 in/36 mm
<i>Horn Exit Diameter</i>	1 in/25.4 mm
<i>Diaphragm Material</i>	Titanium
<i>Sensitivity (1W@1m)</i>	104 dB
<i>Nominal Impedance</i>	16 ohms
<i>Power Handling</i>	75 watts rms, long-term
<i>Frequency Range</i>	1 kHz - 20 kHz
<i>Magnet Type</i>	Ferrite

Horn Design

<i>Horizontal Coverage</i>	90° (1 kHz - 20 kHz)
<i>Vertical Coverage</i>	80° (1 kHz - 20 kHz)
<i>Mouth Size</i>	11.1 in x 6.1 in (283 mm x 154 mm)

Enclosure Construction Features

<i>Basic Design</i>	Asymmetrical Trapezoidal
<i>Material</i>	Polypropylene
<i>Finish</i>	Grey textured finish
<i>Handles</i>	One on side, one on top
<i>Grille</i>	Perforated metal with weather-resistant coating

Line Input Power

<i>Power Consumption</i>	120 watts with musical program and LIMIT LED blinking
<i>US</i>	120 VAC, 60 Hz
<i>Recommended Amperage Service</i>	2.5 amps
<i>Europe</i>	230 VAC, 50 Hz
<i>Recommended Amperage Service</i>	1.25 amps
<i>Japan</i>	100 VAC, 50/60 Hz
<i>Recommended Amperage Service</i>	3.0 amps
<i>AC Connector</i>	3-pin IEC 250 VAC

Control System Functions

<i>Electronic Crossover</i>	
<i>Phase Alignment</i>	
<i>Equalization</i>	
<i>Parametric Equalization</i>	

Safety Features

<i>Protection</i>	Low-frequency Dynamic Bass Protection, Power Supply, and Amplifier Thermal Protection
<i>Display LEDs</i>	Signal, Power, Limit

Physical Properties

<i>Height</i>	20.75 in/527 mm
<i>Width</i>	13.10 in/333 mm
<i>Depth</i>	12.25 in/311 mm
<i>Weight</i>	32 lb/14.5 kg

Mounting Methods

Optional hanging brackets for top and bottom of enclosure (SRM350 Bracket Kit: Part No. 0016404).

Never attempt to suspend the cabinet by its handles. The SRM350 is pole-mountable via the built-in socket on the bottom of the cabinet. Be sure the pole is capable of supporting the weight of the SRM350.

Disclaimer

Since we are always striving to make our products better by incorporating new and improved materials, components, and manufacturing methods, we reserve the right to change these specifications at any time without notice.

“Mackie” and the “Running Man” figure are registered trademarks of LOUD Technologies Inc.

All other brand names mentioned are trademarks or registered trademarks of their respective holders, and are hereby acknowledged.

©2004-2005 LOUD Technologies Inc.
All Rights Reserved.

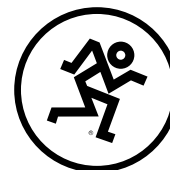

SRM350 BLOCK DIAGRAM

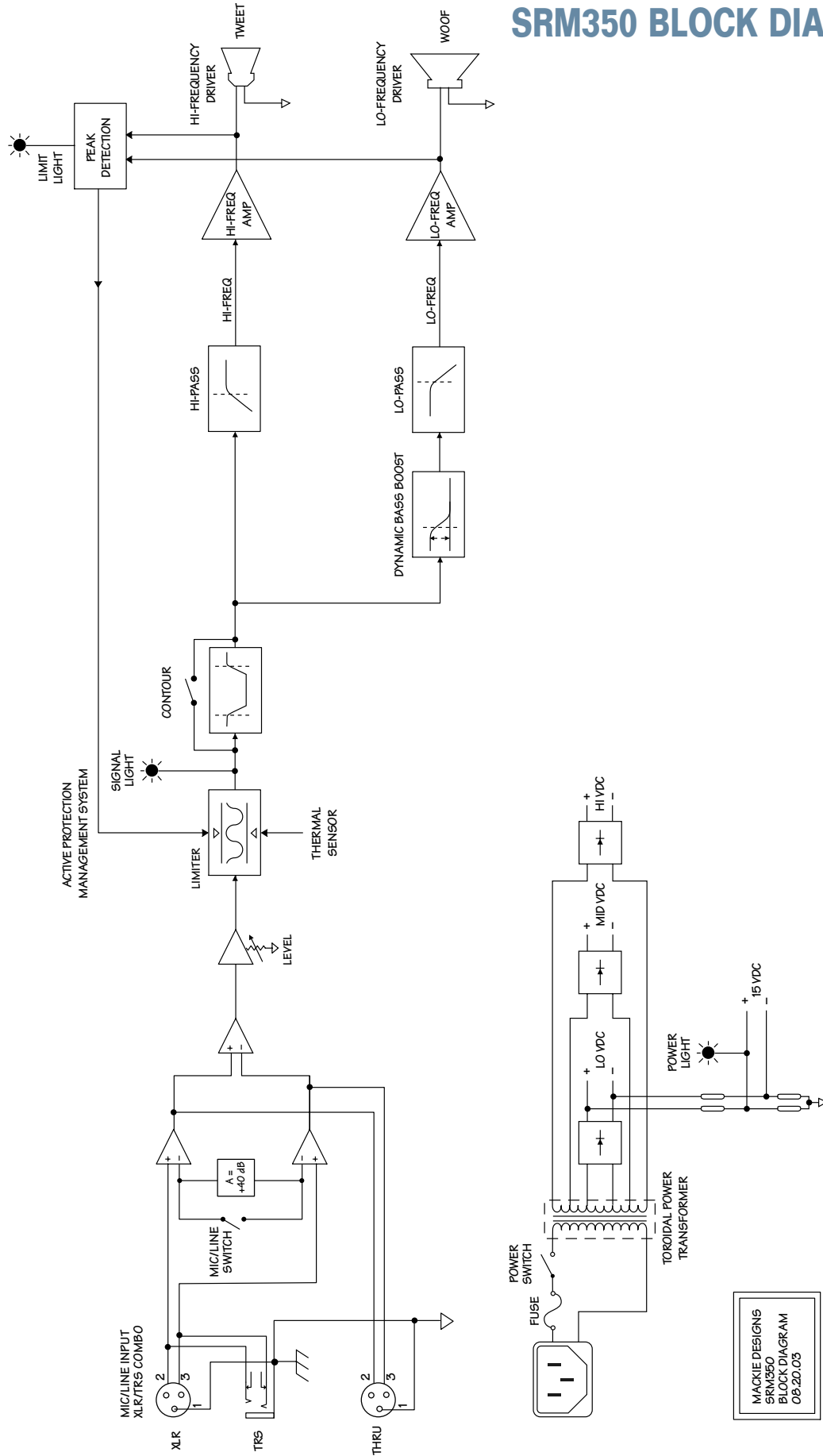

MACKIE DESIGNS
SRM350
BLOCK DIAGRAM
08-20-03

MACKIE®

SRM350 LIMITED WARRANTY

Please keep your sales receipt in a safe place.

A. LOUD Technologies Inc. warrants all materials, workmanship and proper operation of this product for a period of **five years** from the original date of purchase, with the exception of the transducers, including woofers and compression drivers, which are warranted for two years from the original date of purchase. If any defects are found in the materials or workmanship or if the product fails to function properly during the applicable warranty period, LOUD Technologies, at its option, will repair or replace the product. **This warranty applies only to equipment sold and delivered within the U.S. by LOUD Technologies Inc. or its authorized dealers.**

B. Failure to register online or return the product registration card will not void the five-year warranty.

C. Service and repairs of Mackie products are to be performed **only** at a factory-authorized facility (see D below). Unauthorized service, repairs, or modification will void this warranty. To obtain repairs under warranty, you must have a copy of your sales receipt from the authorized Mackie dealer where you purchased the product. It is necessary to establish purchase date and determine whether your Mackie product is within the warranty period.

D. To obtain factory-authorized service:

1. Call Mackie Technical Support at **800/898-3211**, 7 AM to 5 PM Monday through Friday (Pacific Time) to get a Return Authorization (RA). Products returned without an RA number will be refused.
2. Pack the product in its original shipping carton. Do not use "packing peanuts," shredded newspapers, or other material with small particles to pack the product. Please seal the Mackie product in a plastic bag.
3. Also include a note explaining exactly how to duplicate the problem, a copy of the sales receipt with price and date showing, and your return street address (no P.O. boxes or route numbers, please!). If we cannot duplicate the problem or establish the starting date of your Limited Warranty, we may, at our option, charge for service time.
4. Tech Support will tell you where to ship the product. Ship it **freight prepaid** in its original shipping carton.

IMPORTANT: Make sure that the Service Request Number is plainly written on the shipping carton.

E. LOUD Technologies reserves the right to inspect any products that may be the subject of any warranty claims before repair or replacement is carried out. LOUD Technologies may, at our option, require proof of the original date of purchase in the form of a dated copy of the original dealer's invoice or sales receipt. Final determination of warranty coverage lies solely with LOUD Technologies.

F. Any products returned to one of the LOUD Technologies factory-authorized service centers and deemed eligible for repair or replacement under the terms of this warranty will be repaired or replaced within thirty days of receipt by LOUD Technologies. LOUD Technologies and its authorized service centers may use refurbished parts for repair or replacement of any product. Products returned to LOUD Technologies that do not meet the terms of this Warranty will not be repaired unless payment is received for labor, materials, return freight, and insurance. Products repaired under warranty will be returned freight prepaid by LOUD Technologies to any location within the boundaries of the USA.

G. LOUD Technologies warrants all repairs performed for 90 days or for the remainder of the warranty period. This warranty does not extend to damage resulting from improper installation, misuse, neglect or abuse, or to exterior appearance. This warranty is recognized only if the inspection seals and serial number on the unit have not been defaced or removed.

H. LOUD Technologies assumes no responsibility for the quality or timeliness of repairs performed by Authorized Mackie Service Centers.

I. This warranty is extended to the original purchaser and to anyone who may subsequently purchase this product within the applicable warranty period. A copy of the original sales receipt is required to obtain warranty repairs.

J. This is your sole warranty. LOUD Technologies does not authorize any third party, including any dealer or sales representative, to assume any liability on behalf of LOUD Technologies or to make any warranty for LOUD Technologies Inc.

K. THE WARRANTY GIVEN ON THIS PAGE IS THE SOLE WARRANTY GIVEN BY LOUD TECHNOLOGIES INC. AND IS IN LIEU OF ALL OTHER WARRANTIES, EXPRESS AND IMPLIED, INCLUDING THE WARRANTIES OF MERCHANTABILITY AND FITNESS FOR A PARTICULAR PURPOSE. THE WARRANTY GIVEN ON THIS PAGE SHALL BE STRICTLY LIMITED IN DURATION TO FIVE YEARS FROM THE DATE OF ORIGINAL PURCHASE FROM AN AUTHORIZED MACKIE DEALER. UPON EXPIRATION OF THE APPLICABLE WARRANTY PERIOD, LOUD TECHNOLOGIES INC. SHALL HAVE NO FURTHER WARRANTY OBLIGATION OF ANY KIND. LOUD TECHNOLOGIES INC. SHALL NOT BE LIABLE FOR ANY INCIDENTAL, SPECIAL, OR CONSEQUENTIAL DAMAGES THAT MAY RESULT FROM ANY DEFECT IN THE MACKIE PRODUCT OR ANY WARRANTY CLAIM. Some states do not allow exclusion or limitation of incidental, special, or consequential damages or a limitation on how long warranties last, so some of the above limitations and exclusions may not apply to you. This warranty provides specific legal rights and you may have other rights which vary from state to state.

MACKIE®

16220 Wood-Red Road NE • Woodinville, WA 98072 • USA
United States and Canada: 800.898.3211
Europe, Asia, Central and South America: 425.487.4333
Middle East and Africa: 31.20.654.4000
Fax: 425.487.4337 • www.mackie.com
E-mail: sales@mackie.com