



DL32R™

OWNER'S MANUAL



MACKIE®

Important Safety Instructions

1. Read these instructions.
2. Keep these instructions.
3. Heed all warnings.
4. Follow all instructions.
5. Do not use this apparatus near water.
6. Clean only with a dry cloth.
7. Do not block any ventilation openings. Install in accordance with the manufacturer's instructions.
8. Do not install near any heat sources such as radiators, heat registers, stoves, or other apparatus (including amplifiers) that produce heat.
9. Do not defeat the safety purpose of the polarized or grounding-type plug. A polarized plug has two blades with one wider than the other. A grounding-type plug has two blades and a third grounding prong. The wide blade or the third prong are provided for your safety. If the provided plug does not fit into your outlet, consult an electrician for replacement of the obsolete outlet.
10. Protect the power cord from being walked on or pinched particularly at plugs, convenience receptacles, and the point where they exit from the apparatus.
11. Only use attachments/accessories specified by the manufacturer.
12. Unplug this apparatus during lightning storms or when unused for long periods of time.
13. Refer all servicing to qualified service personnel. Servicing is required when the apparatus has been damaged in any way, such as power-supply cord or plug is damaged, liquid has been spilled or objects have fallen into the apparatus, the apparatus has been exposed to rain or moisture, does not operate normally, or has been dropped.
14. This apparatus shall not be exposed to dripping or splashing, and no object filled with liquids, such as vases or beer glasses, shall be placed on the apparatus.
15. Do not overload wall outlets and extension cords as this can result in a risk of fire or electric shock.
16. This apparatus has been designed with Class-I construction and must be connected to a mains socket outlet with a protective earthing connection (the third grounding prong).

17. This apparatus has been equipped with an all-pole, rocker-style AC mains power switch. This switch is located on the rear panel and should remain readily accessible to the user.

18. NOTE: This equipment has been tested and found to comply with the limits for a Class B digital device, pursuant to part 15 of the FCC Rules. These limits are designed to provide reasonable protection against harmful interference in a residential installation. This equipment generates, uses, and can radiate radio frequency energy and, if not installed and used in accordance with the instructions, may cause harmful interference to radio communications. However, there is no guarantee that interference will not occur in a particular installation.

If this equipment does cause harmful interference to radio or television reception, which can be determined by turning the equipment off and on, the user is encouraged to try to correct the interference by one or more of the following measures:

- Reorient or relocate the receiving antenna.
- Increase the separation between the equipment and the receiver.
- Connect the equipment into an outlet on a circuit different from that to which the receiver is connected.
- Consult the dealer or an experienced radio/TV technician for help.

CAUTION: Changes or modifications to this device not expressly approved by LOUD Technologies Inc. could void the user's authority to operate the equipment under FCC rules.

19. This apparatus does not exceed the Class A/Class B (whichever is applicable) limits for radio noise emissions from digital apparatus as set out in the radio interference regulations of the Canadian Department of Communications.

ATTENTION — *Le présent appareil numérique n'émet pas de bruits radioélectriques dépassant les limites applicables aux appareils numériques de class A/de class B (selon le cas) prescrites dans le règlement sur le brouillage radioélectrique édicté par les ministere des communications du Canada.*

20. Exposure to extremely high noise levels may cause permanent hearing loss. Individuals vary considerably in susceptibility to noise-induced hearing loss, but nearly everyone will lose some hearing if exposed to sufficiently intense noise for a period of time. The U.S. Government's Occupational Safety and Health Administration (OSHA) has specified the permissible noise level exposures shown in the following chart.

According to OSHA, any exposure in excess of these permissible limits could result in some hearing loss. To ensure against potentially dangerous exposure to high sound pressure levels, it is recommended that all persons exposed to equipment capable of producing high sound pressure levels use hearing protectors while the equipment is in operation. Ear plugs or protectors in the ear canals or over the ears must be worn when operating the equipment in order to prevent permanent hearing loss if exposure is in excess of the limits set forth here:

Duration, per day in hours	Sound Level dBA, Slow Response	Typical Example
8	90	Duo in small club
6	92	
4	95	Subway Train
3	97	
2	100	Very loud classical music
1.5	102	
1	105	Ben screaming at Troy about deadlines
0.5	110	
0.25 or less	115	Loudest parts at a rock concert

WARNING — To reduce the risk of fire or electric shock, do not expose this apparatus to rain or moisture.

Laitte on liitettävä suojakoskettimilla varustettuun pistorasiaan.

Apparatet må tilkoples jordet stikkontakt.

Apparaten skall anslutas till jordat uttag.

CAUTION

RISK OF ELECTRIC SHOCK! DO NOT OPEN!

CAUTION: TO REDUCE THE RISK OF ELECTRIC SHOCK DO NOT REMOVE COVER (OR BACK). NO USER-SERVICEABLE PARTS INSIDE. REFER SERVICING TO QUALIFIED PERSONNEL.

The lightning flash with arrowhead symbol within an equilateral triangle is intended to alert the user to the presence of uninsulated "dangerous voltage" within the product's enclosure, that may be of significant magnitude to constitute a risk of electric shock to persons.

The exclamation point within an equilateral triangle is intended to alert the user of the presence of important operating and maintaining (servicing) instructions in the literature accompanying the appliance.

The DL32R is cooled with two fans on the rear of the unit. Air is drawn in through the sides and sloping part of the top panel, and is expelled through the rear fan openings. Always maintain at least four inches clearance behind, and one inch clearance on each side of the unit.

When installing into a rack, the rear should be open with at least four inches of clearance behind the rack and adjacent structures (maintaining the one inch clearance on each side of the unit within the rack). For racks with only front ventilation, leave at least one rack space open above and below the unit (maintaining the one inch side and four inch rear clearances around the unit within the rack).

Correct Disposal of this product: This symbol indicates that this product should not be disposed of with your household waste, according to the WEEE Directive (2012/19/EU) and your national law. This product should be handed over to an authorized collection site for recycling waste electrical and electronic equipment (EEE). Improper handling of this type of waste could have a possible negative impact on the environment and human health due to potentially hazardous substances that are generally associated with EEE. At the same time, your cooperation in the correct disposal of this product will contribute to the effective usage of natural resources. For more information about where you can drop off your waste equipment for recycling, please contact your local city office, waste authority, or your household waste disposal service.

Table of Contents

Important Safety Instructions	2
Table Of Contents	3
Chapter 1 : Welcome	4
Chapter 2 : DL32R Front Panel	5
Introduction	5
XLR and 1/4" Inputs	5
XLR Outputs	6
AES Output.....	6
1/4" Monitor L/R Outputs.....	6
Phones Output Jack.....	7
Phones Knob	7
Power LED	7
Network LED	7
Force Update Button	8
Chapter 3 : DL32R Rear Panel	9
Introduction	9
Power Connector	9
Power Switch.....	9
Fan Vents	9
Removable Expansion Slot	10
Network Connector	11
USB A – Drive.....	11
USB B – Computer.....	11
Top of DL32R	12
Appendix A : Hookup Diagrams	15
Appendix B : Technical Information	18
Specifications.....	18
Dimensions	23
Appendix C : Power and Network LEDs Values.....	24
Appendix D : Service Information	25
Appendix E : Glossary Of Terms.....	27
Warranty Statement / GPL Statement.....	35

Chapter 1 : Welcome

Hello everyone! This is the DL32R Owner's Manual...we hope you like it!

Instead of one massive document containing detailed information about the hardware and software, we have divided them into separate manuals. Simply decide if you need assistance with the hardware or software and dive on in. The water here is warm and crystal clear.

The following pages describe the hardware side of things and should remain relatively unchanged throughout the life of your product. The software, though, is another story. The Master Fader app is always being updated...even right now this very minute! This means frequent updates to the Reference Guide, firmware and more. With each major release comes an updated Reference Guide.

So there you have it. Again, we hope you like it. If you have any questions or comments about this Owner's Manual, please contact us at: www.mackie.com/support

About This Guide

This guide is designed to be accessible, with subsections as complete as practical to minimize having to electronically leaf back and forth looking for the whole story. This guide provides the following resources:

- A general overview of the DL32R's facilities and features.
- Dissection-by-dissection description of each input and output.
- Hookup diagrams depicting some of the more common setups.

As the saying goes, "a picture tells a 1000 words". With that thought in mind, we added quite a few illustrations, screen shots and other images throughout to accompany the text.



This icon marks information that is critically important or unique! For your own good, read and remember them...it is a good idea to pay special attention to these areas in the Owner's Manual marked with the "VERY IMPORTANT" hand icon.



There's an illustration of a microscope, so, of course, you're going to get more detailed information when you see this little guy. There are explanations of features and practical tips listed here.



It's a good idea to pay attention to text displayed next to a note icon, as this icon draws attention to certain features and functions relating to the usage of the mixer.

Chapter 2 : DL32R Front Panel

Introduction

Each DL32R mixer is outfitted with 24 XLR input jacks, 8 combo input jacks, 14 XLR output jacks, an XLR AES output jack, 1/4" L/R monitor output jacks, one 1/4" phones output jack (and corresponding phones knob) and power and network LEDs. Let's take a look at each of these features, starting with the inputs.

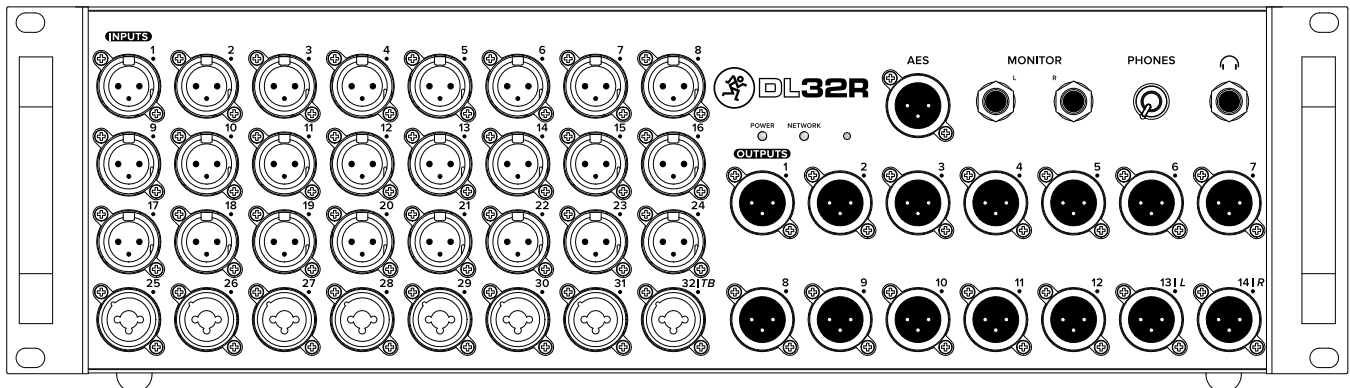

XLR and 1/4" Inputs

All channels may accept a balanced mic or line-level signal using an XLR connector. They are wired as follows, according to standards specified by the AES (Audio Engineering Society).

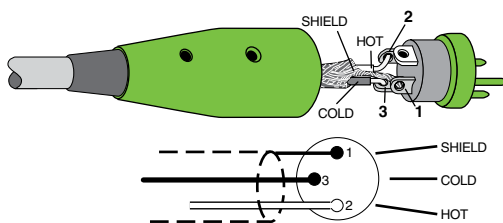

XLR Balanced Wiring:
 Pin 1 = Shield (ground)
 Pin 2 = Positive (+ or hot)
 Pin 3 = Negative (- or cold)

In addition to accepting balanced mic or line-level signals using an XLR connector, channels 25-32 may also accept 1/4" line-level signals driven by balanced or unbalanced sources.

To connect balanced lines to these inputs, use a 1/4" Tip-Ring-Sleeve (TRS) plug. "TRS" stands for Tip-Ring-Sleeve, the three connection points available on a stereo 1/4" or balanced phone jack or plug. TRS jacks and plugs are used for balanced signals and stereo headphones and are wired as follows:

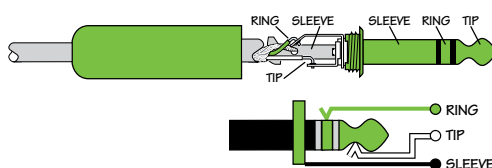

1/4" TRS Balanced Mono Wiring:
 Sleeve = Shield
 Tip = Hot (+)
 Ring = Cold (-)

To connect unbalanced lines to these inputs, use a 1/4" mono (TS) phone plug, wired as follows:

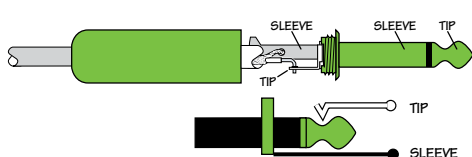

1/4" TS Unbalanced Mono Wiring:
 Sleeve = Shield
 Tip = Hot (+)

XLR Outputs

These 14 male XLR connectors provide balanced line-level signals that represent the end of the mixer, where the signals enter the real world. Connect these to line-level inputs of your main PA system, stage monitors, external effects devices, headphone amplifiers, and/or whatever else you desire. The PA/monitor speaker system could either be passive (powered by external amplifiers) and/or powered (with built-in power amplifiers). You may run separate mixes since all outputs are independent of each other and are completely routable via the Master Fader control software. Pretty cool, huh?!

They are wired as follows, according to standards specified by the AES (Audio Engineering Society):

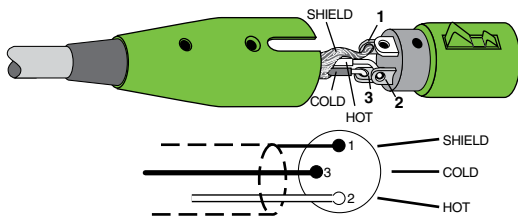

XLR Balanced Wiring:

Pin 1 = Shield (ground)

Pin 2 = Positive (+ or hot)

Pin 3 = Negative (- or cold)

AES Output

This male XLR-style connector provides professional, balanced stereo digital output from the DL32R. Connect this output to the AES digital inputs of an amplifier, system processor, audio distribution system or recording devices. Like the analog outputs, you may select the signals to send to the AES output via the Master Fader control software.



Resist the temptation to use a standard audio-grade XLR cable. AES digital audio data is transmitted at far higher frequencies and require a special cable.

It is wired as follows, according to standards specified by the AES (Audio Engineering Society):

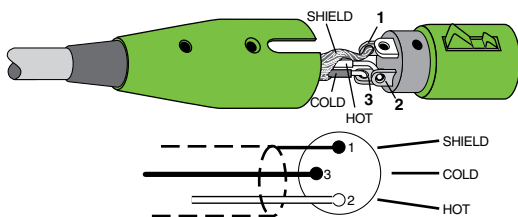

AES Balanced Wiring:

Pin 1 = Shield (ground)

Pin 2 = Positive (+ or hot)

Pin 3 = Negative (- or cold)

1/4" Monitor L/R Outputs

These 1/4" connectors allow you to send balanced or unbalanced line-level outputs to a wireless in-ear monitor system or a pair of studio monitors. These could either be passive studio monitors powered by an external amplifier, or powered studio monitors with built-in power amplifiers. If monitor outputs are not needed, these connectors may be changed to output any signals on the mixer via the Master Fader control software.

To connect balanced lines to these inputs, use a 1/4" Tip-Ring-Sleeve (TRS) plug. "TRS" stands for Tip-Ring-Sleeve, the three connection points available on a stereo 1/4" or balanced phone jack or plug. TRS jacks and plugs are used for balanced signals and stereo headphones and are wired as follows:

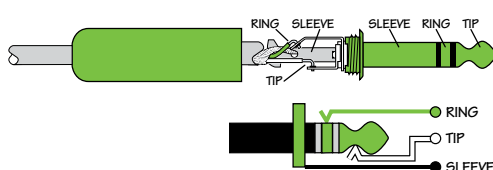

1/4" TRS Balanced Mono Wiring:

Sleeve = Shield

Tip = Hot (+)

Ring = Cold (-)

To connect unbalanced lines to these inputs, use a 1/4" mono (TS) phone plug, wired as follows:

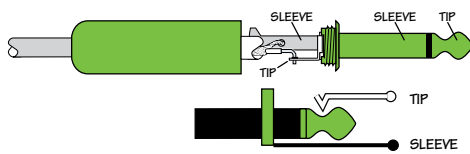

1/4" TS Unbalanced Mono Wiring:

Sleeve = Shield

Tip = Hot (+)



Unbalanced cables can be noisy. If the studio monitors support balanced cables, we highly recommend using those instead of unbalanced cables.

Phones Output Jack

This 1/4" TRS connector supplies the output to stereo headphones. The volume is controlled with the phones knob located to the left of the output jack. The signals sent to this jack are the same as the signals sent to the monitor outputs, described on the previous page.

The phones output follows standard conventions:

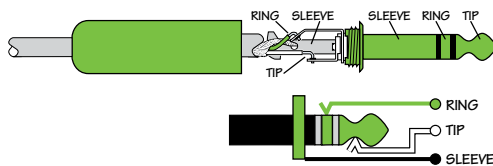

Tip = Left channel

Ring = Right channel

Sleeve = Ground

Phones Knob

This knob is used to adjust the volume from the phones output jack, from off to maximum gain (max). The phones knob is an analog control, and is therefore NOT recallable.



Warning: The headphone amp is loud and could cause permanent hearing damage.

Even intermediate levels may be painfully loud with some headphones. BE CAREFUL!

Always turn the phones knob all the way down before connecting headphones, soloing a channel or doing anything new that may affect the headphone volume. Then turn it up slowly as you listen carefully.

Power LED

For the most part, this dual-colored LED will illuminate solid green when the DL32R is powered on and functioning normally. However, this LED could also illuminate red, and it has several other identifiers, as well. Please refer to the table in Appendix C for all possibilities.

Network LED

For the most part, this dual-colored LED will illuminate solid green when the basic card is functioning normally and an iPad connection is established. However, this LED could also illuminate red, and it has several other identifiers, as well. Please refer to the table in Appendix C for all possibilities.

Force Update Button

The force update button is conveniently located right next to the power and network LEDs and just below the awesome DL32R logo. In a perfect world, this button would just sit there without a care in the world, umbrella drink in hand, beach, surf and sun on a daily basis. In all likelihood, this button will live his / her dream out, while the rest of us can only dream of such a life.

The DL32R and Master Fader app do a great job at letting you know when either (or both) the software and firmware need updating, but this button here forces a complete firmware update *if the need ever arrives*.

Here's how to force a firmware update: first, turn the mixer off. Now, with a bent paperclip, poke the force update button, then power up the mixer with the button depressed. The mixer will boot and you will be prompted with an update bubble the next time an iPad with the Master Fader app is turned on.



Now that you know how to force an update, here's a friendly reminder that you should let the button remain peaceful, calm and tranquil, only forcing a firmware update if instructed by Tech Support. Thank you for listening!



Save any current show to your iPad before forcing an update or you may lose it. The show and your sanity!

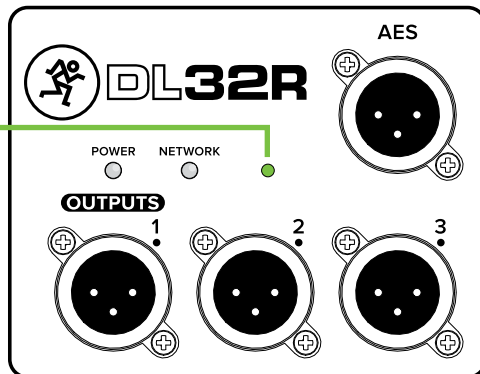

Chapter 3 : DL32R Rear Panel

Introduction

The rear panel of each DL32R is outfitted with a power connector, a power switch, two fan vents, a removable expansion slot, an Ethernet connector and two USB slots to stream multichannel audio to and from (one for a hard drive, one for a computer).

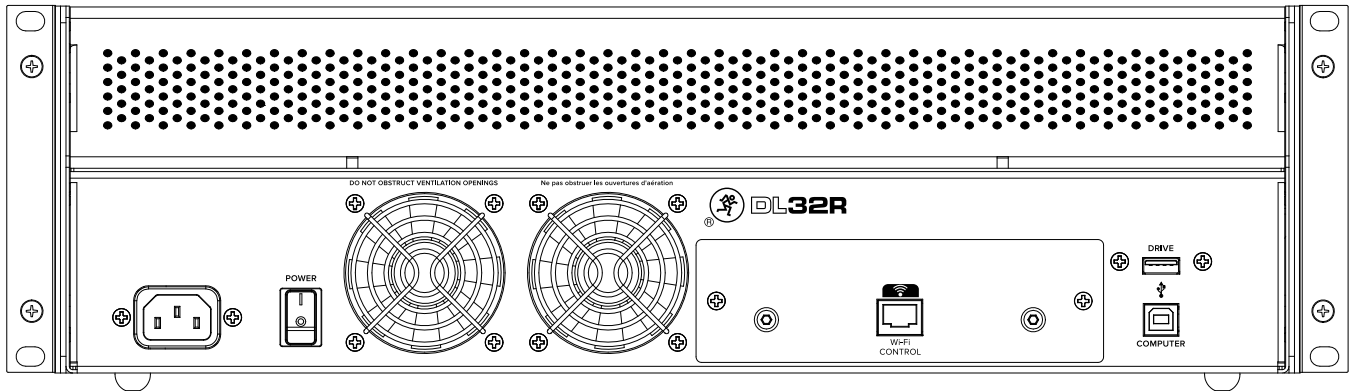

Power Connector

This is a standard 3-prong IEC power connector. Connect the detachable power cord (included in the packaging) to the power receptacle, and plug the other end of the power cord into an AC outlet.



Make sure that the AC power is matched to the AC power indicated on the rear panel (below the IEC receptacle).



Warning: Disconnecting the plug's ground pin is dangerous. Don't do it!

In fact, it's a bad idea to remove anything from – or add anything to, for that matter – the line cord. Again, don't do it!

Power Switch

Press the top of this rocker switch in to turn the DL32R on and press the bottom of this switch to turn the mixer off.



As a general guide, the DL32R should be turned on first, before any external power amplifiers or powered speakers. As such, it should also be turned off last. This will reduce the possibility of any turn-on or turn-off thumps in the PA.

Fan Vents

The DL32R is cooled with two fans on the rear of the unit. Air is drawn in through the sides and sloping part of the top panel, and is expelled through the rear fan openings. The speed of these fans is adjusted automatically based on the temperature of the unit and its surroundings.



Always maintain at least four inches clearance behind, and one inch clearance on each side of the unit.



When installing into a rack, the rear should be open with at least four inches of clearance behind the rack and adjacent structures (maintaining the one inch clearance on each side of the unit within the rack). For racks with only front ventilation, leave at least one rack space open above and below the unit (maintaining the one inch side and four inch rear clearances around the unit within the rack).

Removable Expansion Slot

This slot accepts expansion cards for audio networking, recording and other control options. Each card contains pull tabs for easy installation and removal of cards, as well as two Phillips head screws to hand-tighten the card to the mixer. The DL32R comes with a standard network card already installed. As seen in the illustration below, this card contains a single network port for control.

Here's how to remove a card from the mixer's expansion slot:

- (1)** — Using a Phillips screwdriver, unscrew and remove the two screws keeping the card secured to the mixer. Keep the screws in a safe place; you're going to re-use them!
- (2)** — Using your index finger and thumb of each hand, grab the card's two pull tabs and gently remove the card straight out from the mixer.
- (3)** — Place the card in an antistatic bag – one is included with the new card – and keep it in a safe place; you might re-use it some day.

Adding a card to the mixer is basically the same steps as above, but in reverse:

- (1)** — Remove the card from the antistatic bag and admire its beauty.
- (2)** — Using your index finger and thumb of each hand, grab the card's two pull tabs and gently slide the card straight into the mixer.



Make sure to line up the card with the side rails before sliding the card in. There are notches located at the bottom on each side of the expansion slot to help line up and easily guide the card.

- (3)** — Using a Phillips screwdriver, hand-tighten the two screws (that you kept in a safe place!), to keep the card secured to the mixer.

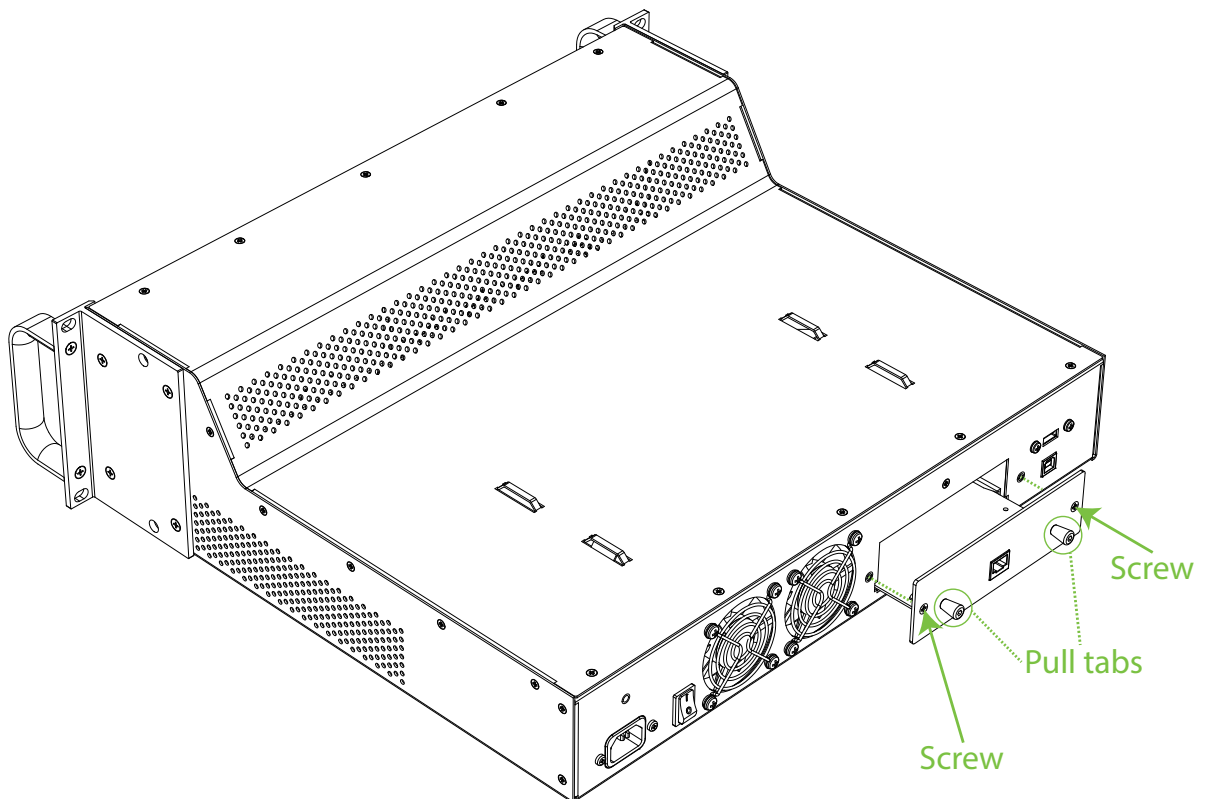

Network Connector

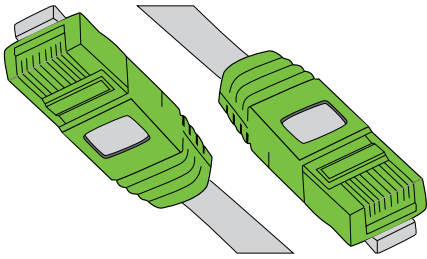

As stated previously, the DL32R arrives equipped with an expansion card that contains a single network port for control. The purpose in life of this 100 Mb network connector is to connect the mixer to a Wi-Fi router via CAT5 Ethernet cable, thus enabling wireless control.

Plug one end of the CAT5 Ethernet cable into the mixer's network connector and the other end of the CAT5 Ethernet cable into a LAN port on the router, NOT a WAN port. Most routers allow the use of either a straight-wired cable or crossover cable, but if you have a choice, a straight-wired CAT5 Ethernet cable is the way to go to ensure smooth operation with any router.



Complete directions for setting up the router may be found in the Master Fader Reference Guide.

USB A – Drive

The DL32R's USB type A connector allows 32 channel (48 kHz, 24-bit) recording and playback to (and from) a USB hard drive.

Any combination of channels or outputs may be selected as the record source and playback destination.



USB A and USB B connectors may NOT be used simultaneously. If a hard drive is connected to USB A, it will take priority over anything connected to USB B. For example, if you are recording to a DAW (via computer connected to the USB B port) and connect a hard drive to the USB A port, the hard drive will mount and the DAW recording interrupted. Additionally, the DL32R will no longer show up as an available device until the USB A connection is removed and the USB B connection is disconnected and reconnected again.

USB B – Computer

The DL32R's USB type B connector allows 32x32 channels of recording and playback to a connected computer over USB 2.0 by presenting the DL32R as an audio class 2.0 compliant device. What this means is that connecting it to a Mac should work automatically with no additional drivers. [Windows drivers will require separate installation, but this is included. Simply download it from our website!](#)

Additionally, you may stream audio directly to and from an iPad using the iPad camera connection kit.

Any combination of channels or outputs may be selected as the record source and playback destination.



USB A and USB B connectors may NOT be used simultaneously. If a hard drive is connected to USB A, it will take priority over anything connected to USB B. For example, if you are recording to a DAW (via computer connected to the USB B port) and connect a hard drive to the USB A port, the hard drive will mount and the DAW recording interrupted. Additionally, the DL32R will no longer show up as an available device until the USB A connection is removed and the USB B connection is disconnected and reconnected again.

Top of DL32R

Believe it or not, the flat surface on top of the mixer serves a purpose. Minimize lengthy spaghetti madness by placing the Wi-Fi router and/or USB hard drive up here. We even included straps to hold it down! You can also use zip ties for permanent installs or Hook and Loop tape on both sides to make the products even more secure, yet easily removable.

Running
Man
Logo



Here's how to add the straps to the mixer:

(1) — Slide the strap [Running Man logo face down] left to right underneath the rear left bridge of the mixer until it catches.

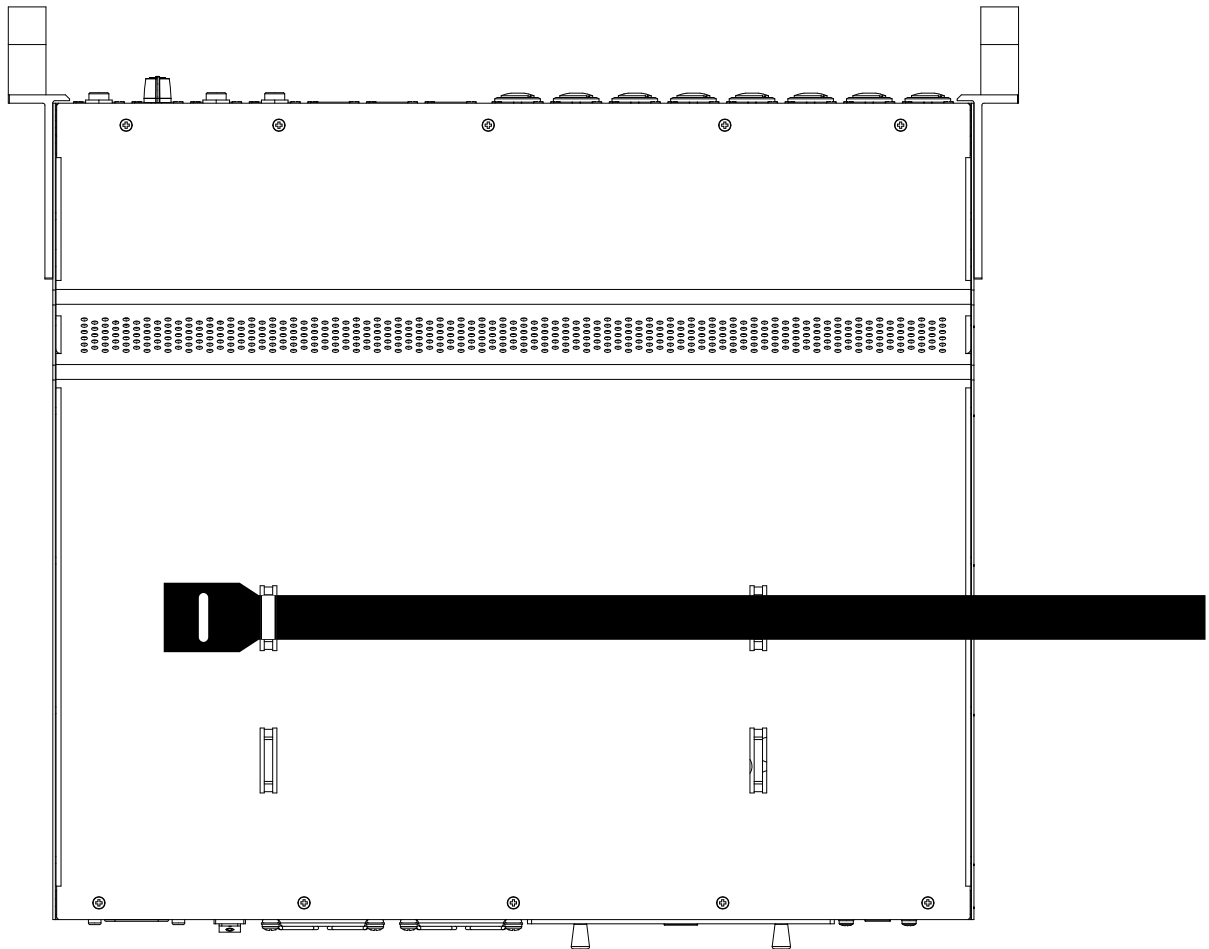

(2) — Loop the strap over [Running Man logo face up] right to left inserting it and sliding it through the slit of the strap. Hand-tighten 'til snug.

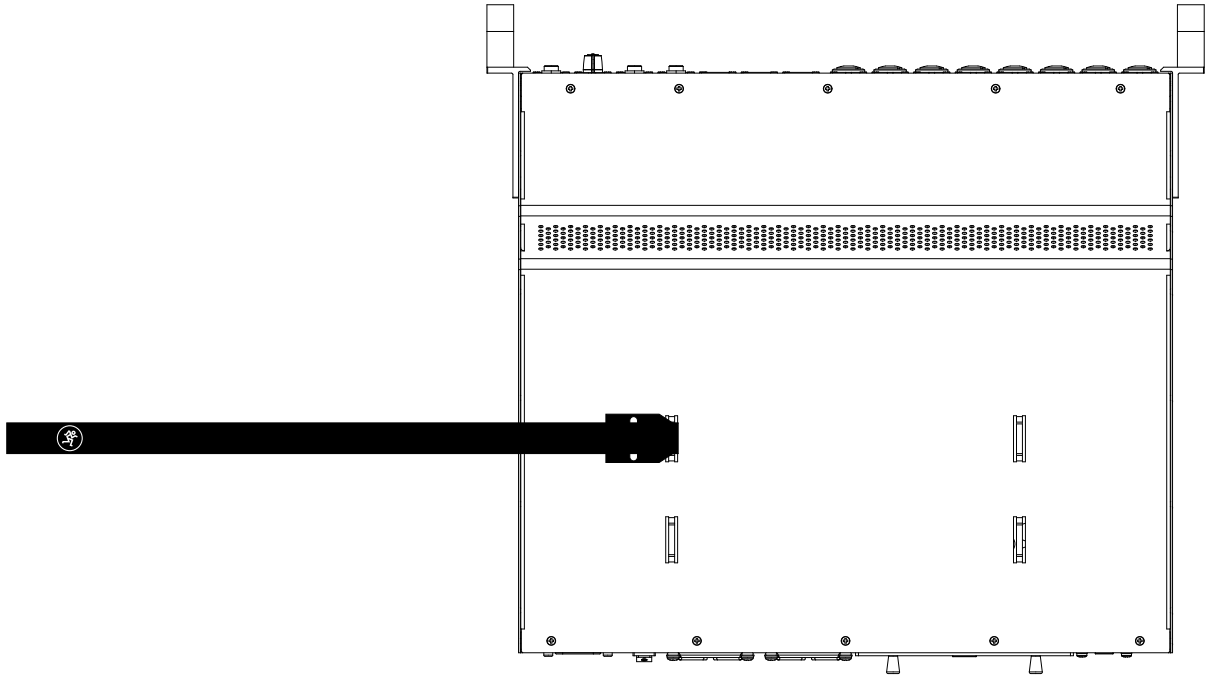

(3) — Now slide the strap [Running Man logo face down] left to right (again), this time underneath the rear right bridge of the mixer.

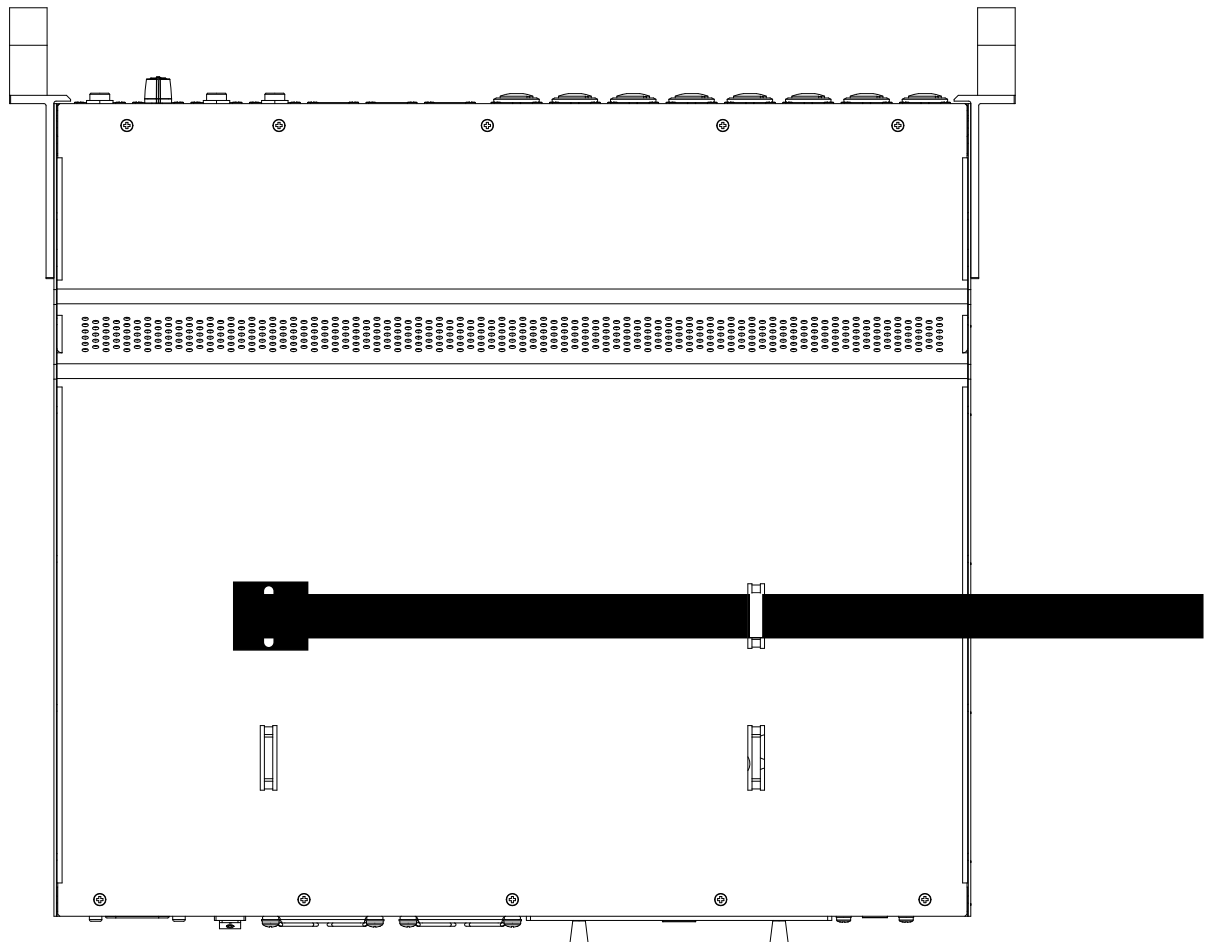

- (4) — Repeat steps 1–3 for the front bridges of the mixer.
- (5) — Place the Wi-Fi router and/or USB hard drive on top of the mixer, but underneath the straps.
- (6) — Loop both straps back over [Running Man logos face up] right to left until the Wi-Fi router and/or USB hard drive are secured underneath the straps.
- (7) — Lay the straps down to itself to secure it via magic...or hook-and-loop. You decide.

See the image below for a visual representation of what your mixer with Wi-Fi router and/or USB hard drive secured by the straps might look like.

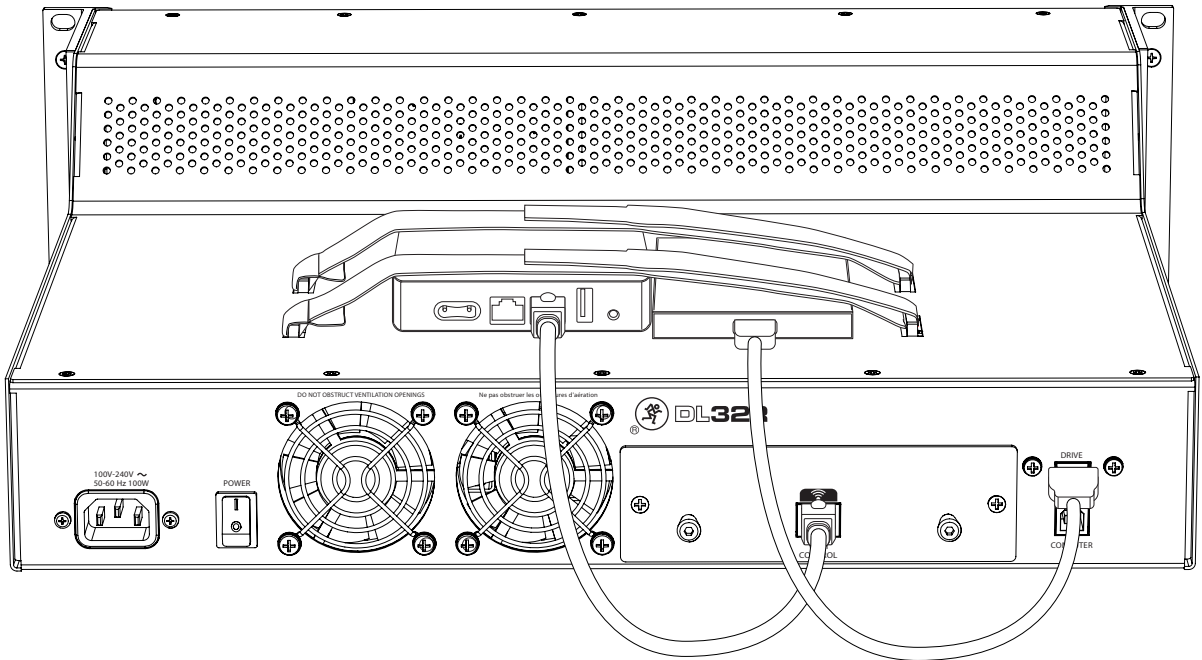

Don't be surprised if you see your cat up there when nothing else is on top of the DL32R. We witnessed this more than once during our sessions. While we sure do love these evil furry creatures, they're not the greatest engineers. Make sure it doesn't get a hold of an iPad or you're in for a long night of awful mewxing.



Appendix A : Hookup Diagrams

Live Sound: House Engineer

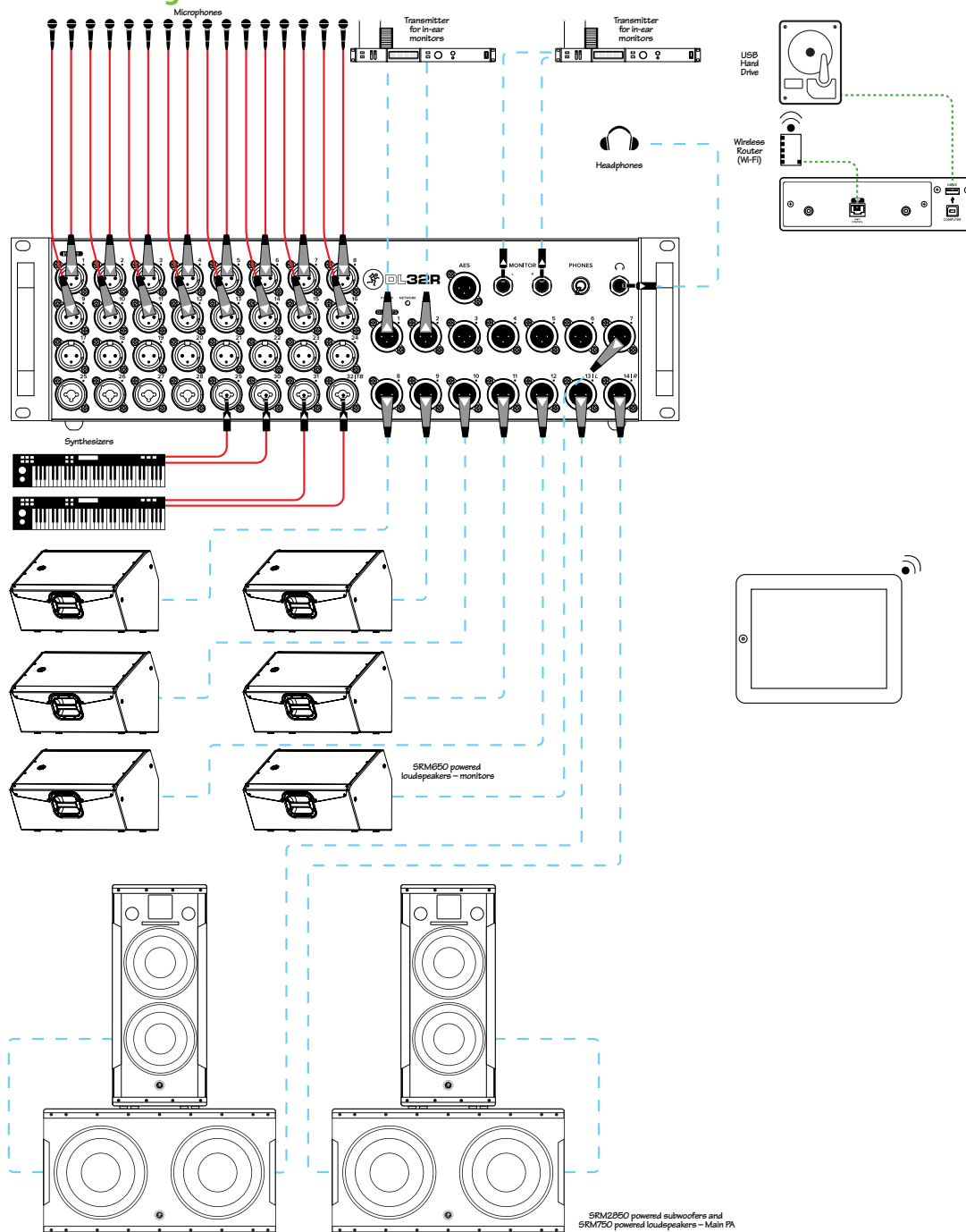

Here's a pretty common setup utilizing the DL32R. Mics are connected to input channels 1-16 which may be used to mic up a drum set, guitar and bass cabinets, acoustic guitar, lead and background vocals, a horn section, etc. A pair of synthesizers are connected to channels 29-30 and 31-32 via 1/4" input jacks. And there are still an additional 12 unused inputs available for extra mics!

Outputs 13-14 are assigned as the L/R main outs [default]. These connect directly to a pair of SRM2850 powered subwoofers which are connected to a pair of SRM750 powered loudspeakers. Outputs 7-12 are assigned as aux sends 1-6. These are sent to six separate SRM650 powered loudspeakers set up as monitors for the band. Outputs 1-2 and the monitor L/R outputs are sent to transmitters for in-ear monitors.

Utilizing an iPad, the house engineer will set the LR main mix, as well as get the multitrack recording of the band's live show.

Live Sound: Self-Engineered

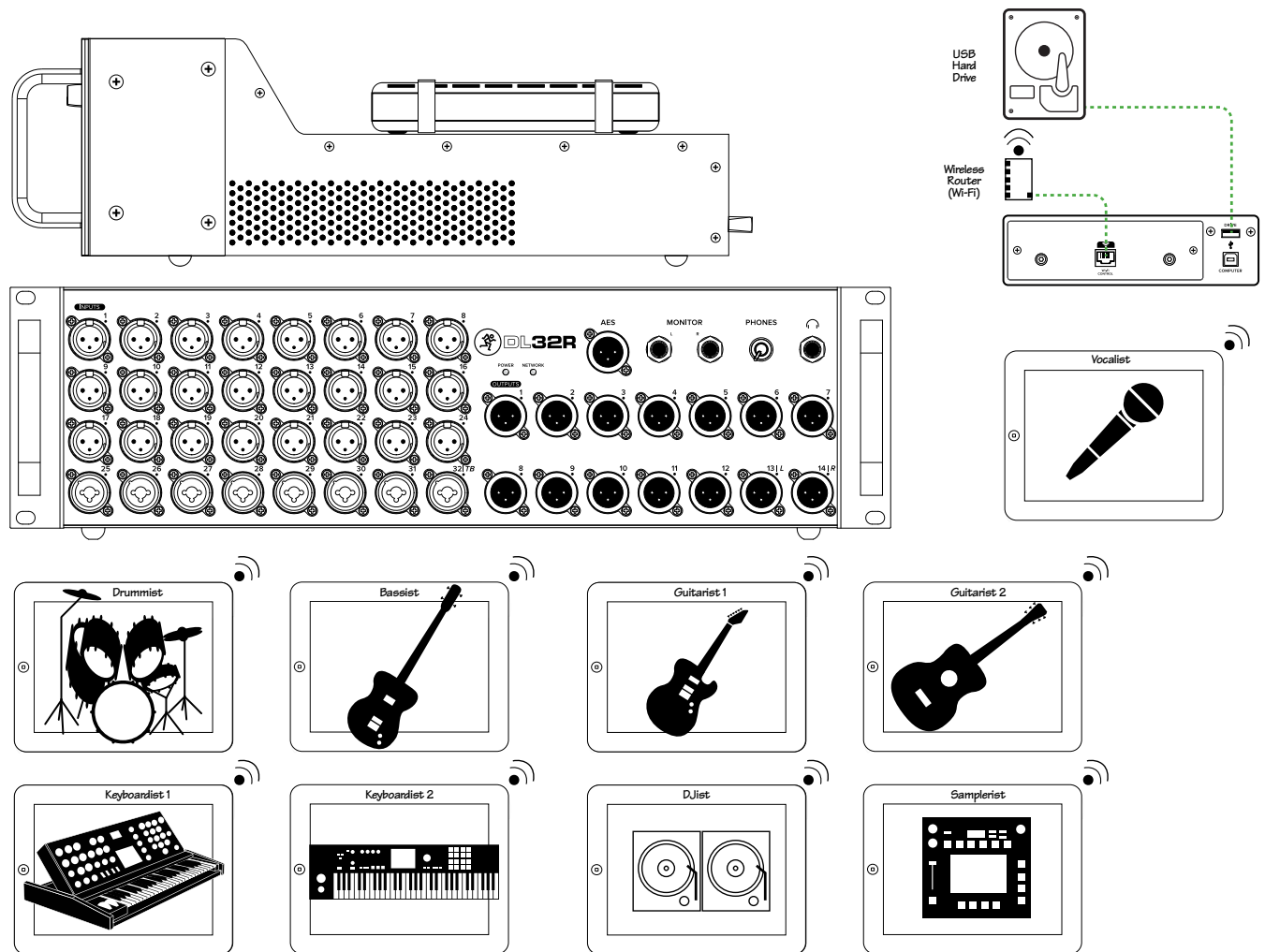

Here's a setup for all the musicians out there who whine for "more me" in the mix. Set up and connect each musician's instrument, the PA and monitors just like they would be in any other live situation.

The house engineer's iPad is at the bar (right next to a shot and a beer, of course – unseen in the illustration above; after all, it is a good-sized venue) where he/she will set the LR main mix, as well as get the multitrack recording of the band's live show.

Up to 20 iOS devices may be connected to the DL32R. As such, each band member may control their own mix from their own "station". As seen in the illustration above, the vocalist, drummer, bassist, each guitarist, each keyboardist, DJist and samplerist each have an iPad. Nine musicians, nine iPads, nine-plus outputs (configured as auxes). Coincidence? We think not. Whining problem solved!

Studio Recording

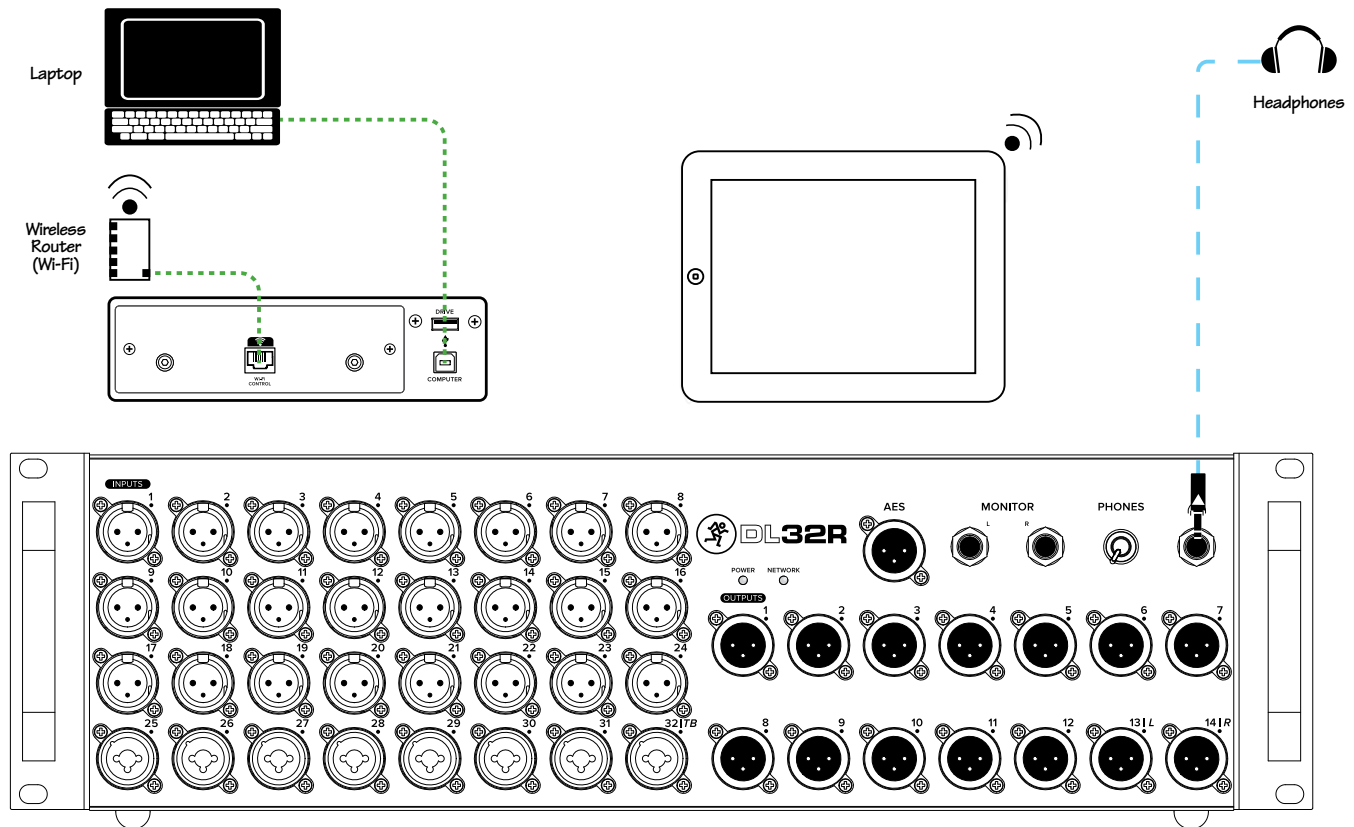

In addition to being a live mixer, the DL32R also makes a great mixer for studio recording.

Start by simply setting up and connecting all the necessary mics, instruments and other inputs.

Next, set the levels and create the mix you desire with the iPad.

A computer is connected to the USB B connector on the rear panel of the DL32R for recording up to 32x32 channels.

Now listen to your masterpiece via headphones (connected to the phones output jack) or studio monitors (connected to the monitor L/R output jacks).

Voilà, you just recorded and played back up to 32x32 channels while sittin' in your underwear...the only way to write and record!



As much as we like to write and record in our underwear (and urge you to do the same – it's comfortable!), please save it for the studio. No one's interested in seeing you play a live gig in your Fruit of the Looms.. Trust us, we did it...once.

Appendix B : Technical Information

Specifications

General Digital

Sample Rate:.....	48 kHz
A/D/A Bit Depth:	24-bit
System Latency	
Analog Input > Main Bus > Analog Output:	1.5 ms
0 dBFS Reference:	+22 dBu

Frequency Response

All inputs to all outputs:	± 0 , -1 dB, 20 Hz to 20 kHz
----------------------------------	----------------------------------

Distortion

THD (mic input to main output, 1 kHz, -1 dBFS):.....	<0.005%
--	---------

Noise / Dynamic Range / Signal-to-Noise Ratio

EIN (150 Ω termination):.....	-128 dBu
Crosstalk	
Analog XLR input-input:	<-105 dB @ 1 kHz (min. gain)
	<-80 dB @ 1 kHz (max. gain)
Analog XLR / TRS output-output:	<-100 dB @ 1 kHz
Signal-to-Noise Ratio (ref +4 dBu, one channel and main fader at unity, A-weighted):.....	92 dB
Output Noise (A-weighted) – Muted Output:	-90 dB
Dynamic Range	
Analog Input to Analog Output – One channel and main fader at unity, A-weighted.....	109 dB
Analog Input – Unity gain, to analog clipping, -60 dBFS signal, A-weighted	111 dB
Analog Output –To analog clipping, -60 dBFS signal, A-weighted	111 dB
CMRR:.....	>70 dB @1 kHz (60 dB gain)

Specifications Continued...

Analog Inputs

Connectors:..... 1-24: XLR Balanced, 25-32: Combo XLR / TRS Balanced

XLR Mic Pre:Onyx+

Input Impedance: 1-24: 3k Ω , 25-32: 3 k Ω mic [XLR], 30 k Ω line [1/4"]

Max Input Level:XLR: +21 dBu
1/4": +30 dBu

Gain [digitally controlled analog]:.....
XLR: 0 to 60 dB [3 dB steps]
1/4": -20 to 40 dB [3 dB steps]

48V Phantom Power (XLR):.....48 VDC, 10 mA max per mic, with up to 16 simultaneously
5 mA max per mic, with up to 32 simultaneously.
Individual digital controller per channel.

Analog Outputs

Connectors:.....XLR Balanced

Output Impedance:600 Ω

Max Output Level: +21 dBu

Analog Monitor Outputs L/R

Connectors:..... 1/4" TRS Impedance Balanced
(Supports balanced / unbalanced operation)

Output Impedance: 240 Ω Balanced, 120 Ω Unbalanced

Max Output Level: +21 dBu

Specifications Continued...

Analog Headphone Out

Connector:..... 1/4" TRS Stereo
Max Output Level: +18.0 dBu into 600 Ω
+19.5 dBu max into 100 k Ω

AES Output

Format: AES3 Professional, 48 kHz, 24-bit stereo
Connector:..... XLR Balanced
Output Impedance: 110 Ω

USB – Streaming¹

Connection: USB 2.0 High Speed (as a device)
Connector:..... USB-B
Supported MS Windows [Driver installation required]:..... Windows 7, 8, 10
Supported Mac OS [Audio Class 2.0 Compliant, no driver required]:..... OS X 10.8.4, 10.9, 10.10, 10.11
Audio:..... 32 in / 32 out, 48 kHz, 16/24-bit

USB – HDD Recording / Playback¹

Connection: USB 2.0 High Speed (as a host)
Connector:..... USB-A
Audio:..... 1-24 channel, 48 kHz, 16/24-bit (multichannel .wav)
Supported Devices:..... USB 2.0 / 3.0 Class Compliant HDD
HDD Format:..... FAT32
Bus Power: 5V, 1A max

¹ Streaming and HDD Record / Playback are not available simultaneously.

Specifications Continued...

Networking

Connection [Using Basic Network Option Card]: 100 Mb Ethernet
 Control: Complete
 Simultaneous Control: 20 iOS Devices

Supported Devices

iOS Version Requirement: For optimal performance, we suggest using
 the latest iOS version [iOS 8.0 minimum]
 iPad Version Requirement: All iPad models (except the original iPad),
 Future iPad devices²
 iPhone / iPod touch Version Requirement: iPhone 4, iPhone 4S, iPhone 5, iPhone 5c, iPhone 5s,
 iPhone 6, iPhone 6s, iPhone 6 Plus, iPhone 6s Plus,
 iPod touch (5th generation),
 Future iPhone and iPod touch devices²
 Control Application: [Master Fader App](#)³
 For optimal performance and latest feature set,
 we suggest using the latest Master Fader app

DSP

36 input channels with 4-band PEQ + HPF, gate and compression
 32 stereo-linkable input channels
 4 stereo-linkable return channels (PEQ and compression only)
 28 output busses with 4-band PEQ + HPF/LPF, 31-band GEQ, comp/limiter, alignment delay and RTA
 14 stereo-linkable aux sends
 6 stereo-linkable matrix busses
 6 stereo-linkable subgroups (PEQ and compression only)
 Main L/R busses
 6 VCAs and 6 mute groups
 3 stereo FX processors (2 reverb, 1 delay) with dedicated sends and returns
 Full I/O routing with A/B sources per channel
 Assignable oscillator including pink/white noise and sine waves
 Modern and Vintage options per processor

² This assumes, of course, that future iOS devices do not communicate via infrared, radiation, television, sparklers, hoagies, frickin' laser beams, or some other crazy, fandangled new contraption. Even then, we'll still give it the 'ol college try. After all, we do have sharks at the ready.

³ <https://itunes.apple.com/us/app/mackie-master-fader/id511500747?mt=8>

Specifications Continued...

Power

Power Requirements: 100 VAC – 240 VAC, 50 – 60 Hz, Universal Supply
Line Cord:..... User-replaceable IEC
Power Consumption:..... 100 W max
Operating Temperature [extended ambient temperature]:..... 32-104 °F / 0- 40 °C

Dimensions

Height: 5.4 in / 138 mm
Width:..... 19.0 in / 483 mm
Depth: 17.5 in / 443 mm
Weight: 18.0 lb / 8.2 kg
Rack: 3U Rack Spaces

About

Part Number, Rev and Date:..... SW1078, Rev D, November 2015

©2015 LOUD Technologies Inc. All rights reserved. Apple, iPad, iPhone and iPod touch are trademarks of Apple Inc., registered in the U.S. and other countries. All other marks are Registered Trademarks, or Trademarks, of LOUD Technologies in the United States and other countries. DL32R Patent Pending.

“Made for iPad” means that an electronic accessory has been designed to connect specifically to iPad and has been certified by the developer to meet Apple performance standards. Apple is not responsible for the operation of this device or its compliance with safety and regulatory standards. Please note that the use of this accessory with iPad may affect wireless performance.

LOUD Technologies Inc. is always striving to improve our products by incorporating new and improved materials, components, and manufacturing methods. Therefore, we reserve the right to change these specifications at any time without notice.

Please check our website for any updates to this Reference Guide: www.mackie.com.

DL32R Dimensions

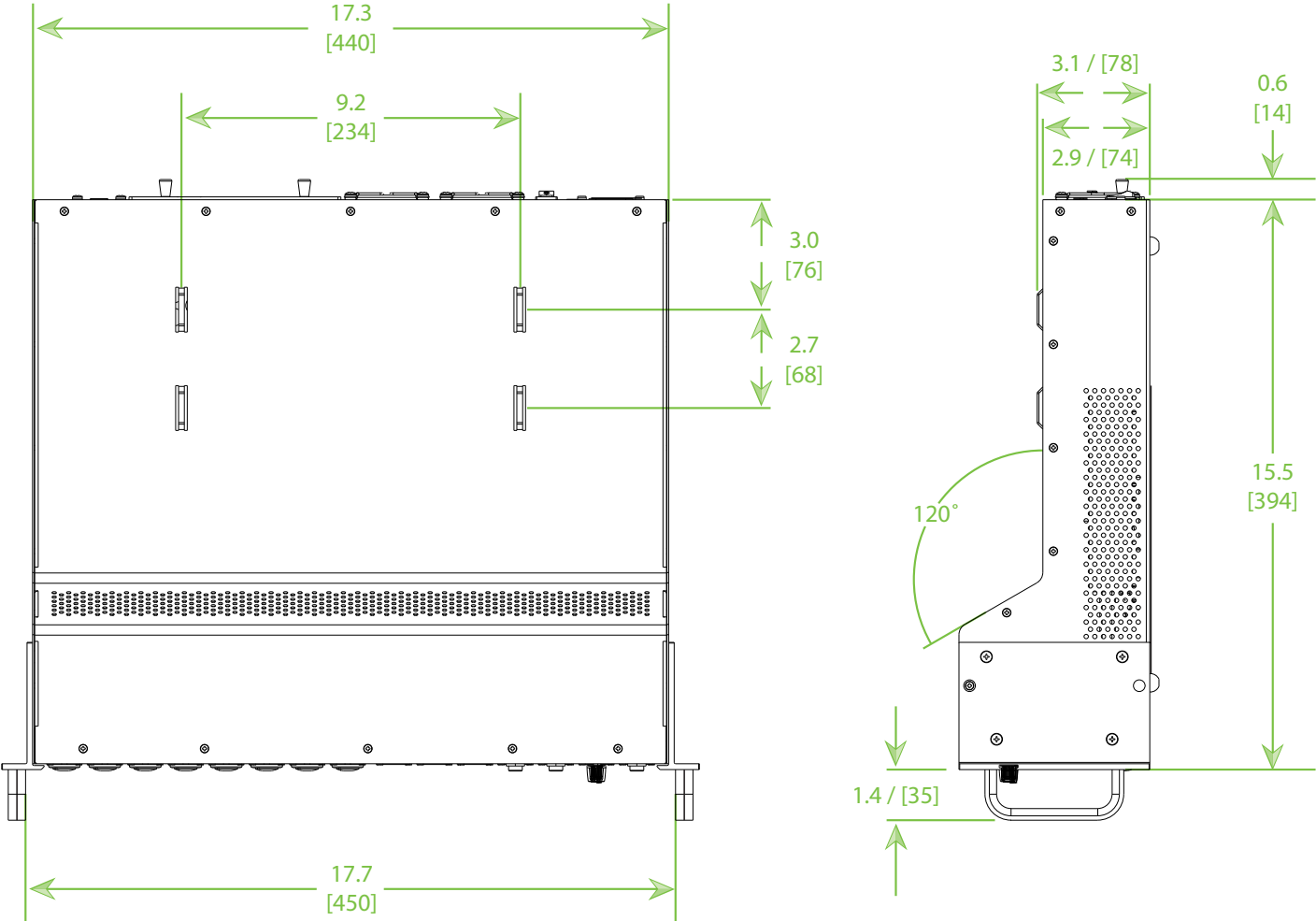

Weight
18.0 lb / 8.2 kg

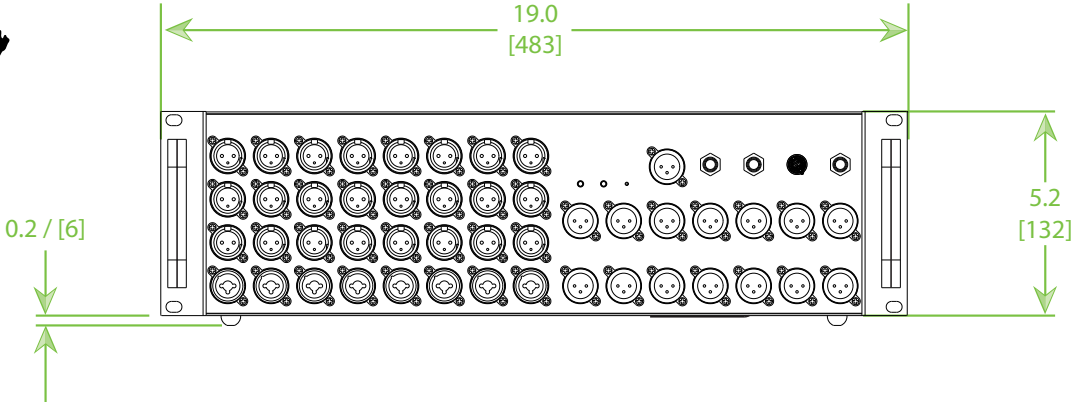

Appendix C : Power and Network LEDs Values

Power LED Color	Power State	Network LED Color	Network State	Description
Off	Off	Off	Off	Unit off.
Green	Solid			Powered on and functioning normally. Turns green when the DL32R finishes booting properly.
Green	Slow Flashing	Green	Slow Flashing	Force update awaiting firmware update. iPad connection is not yet established.
Green	Slow Flashing	Green	Solid	Force update awaiting firmware update. iPad connection is established.
Green	Rapid Flashing	Green	Solid	Firmware update in progress.
Green	Rapid Flashing	Green	Rapid Flashing	Identify function has been activated using the Dante Controller. Flashes for 15 seconds, 2 flashes per second.
Red	Solid	Off	Off	Default power on until the DL32R boots successfully.
Red	Rapid Flashing			Error. Some problem with the hardware processing or mixing. Turn the mixer off, wait 30 seconds, then power back up. Contact Technical Support if this issue persists.
		Green	Solid	At least one iOS device is connected and controlling the mixer AND Basic Card: Networking card is functioning. Dante Card: Dante Networking card is functioning. DL32R is Dante network slave and is synchronized to the clock master, or the DL32R is the Dante network clock master.
		Green	Slow Flashing	No iOS device connection has been established AND Basic Card: Networking card is functioning. Dante Card: Dante Networking card is functioning. DL32R is Dante network slave and is synchronized to the clock master, or the DL32R is the Dante network clock master.
		Red	Solid	Basic Card: Not yet implemented. Dante Card: Dante clock fault or network cable is not connected to either Dante port.
		Red / Green	Alternate Flashing Red/Green	Dante Card: Waiting for Dante Receive Channel Subscriptions to be established. This may take up to 45 seconds.
Red	Rapid Flashing	Red	Rapid Flashing	No network card found or network card failed to boot.

Appendix D : Service Information

Troubleshooting

If you think your DL32R has a problem, please check out the following troubleshooting tips and do your best to confirm the problem. Visit the Support section of our website (www.mackie.com/support) to get some ideas or contact our technical support heroes. You may find the answer to the problem without having to send your DL32R away.

Here are three useful tips that could correct any of the issues outlined below (or possibly any other issue that we haven't yet discovered):

(1) — Restart the iPad. Don't just restart the Master Fader app. *Restart the iPad!* Completely power it down, then power it back up.

(2) — Restart the mixer. This is especially useful after firmware and software updates where the mixer and iPad aren't quite on the same page. A simple reboot can sometimes work great wonders.

(3) — Restart the router. Internet disconnectivity got you down? Unplug and re-plug the router. This may resolve any connection issues.

There are no user serviceable parts. If none of these tips work, please refer to "Repair" on the next page to find out how to proceed.

No Power

- Our favorite question. Is it plugged in? Make sure the AC outlet is live [check with a tester or lamp].
- Our second favorite question. Is the rear panel power switch in the ON position?
- Are all the lights out in town? If so, contact the local power company to get power restored.

No Sound

- Are all the connections good and sound? Make sure all of the connecting cables work and are securely connected at both ends. Try the same source signal in another channel, set up *exactly* like the suspect channel.
- Is the signal source powered on? Is it working (and making union scale)?

Noise / Hum

- Are all the connections good and sound? Make sure all of the connecting cables work and are securely connected at both ends. Try the same source signal in another channel, set up *exactly* like the suspect channel.
- Are you using unbalanced cables? Swap them out with balanced cables to see if that fixes the problem.
- Turn the input gains down one-by-one. If the offending noise disappears, it's either that input or whatever is plugged into it. If you unplug the whatever-is-plugged-into-it and turn the input gain back up and the noise is gone, it's from your whatever.
- Is phantom power required for the microphone?
- Sometimes it helps to plug all the audio equipment into the same AC circuit so they share a common ground. Make it so.
- Has the band been together long?

No Interwebs

- Read the chapter titled "Wireless Setup" in the Master Fader Reference Guide. This section is very important and reading it cover-to-cover is the best troubleshooting.
- Is your iPad connected to the correct wireless network? Go to iPad Settings > Wi-Fi and ensure that it didn't hop onto to a different wireless network.
- Did you select the wireless DL32R from the tools > devices screen?
- Are you running the latest and greatest master fader and DL Series firmware? Go to the App Store and check for an update.
- Did you connect the Ethernet cable to the correct port on the router? Be sure to use the LAN port and not the WAN port.
- Did you connect and then power on the Wi-Fi router BEFORE turning on the mixer?
- Leave the Master Fader and then return by pressing the Home button on the iPad.
- Force quit the Master Fader app.
- Try another Ethernet cable.
- Try another Wi-Fi router.

Repair

For warranty service, refer to the warranty information on page 35.

Non-warranty service for our products is available at a factory-authorized service center. To locate the nearest service center, visit www.mackie.com/support. Service for our products living outside the United States can be obtained through local dealers or distributors.

If you do not have access to our website, you can call our Tech Support department at 1-800-898-3211, Monday-Friday during normal business hours, Pacific Time, to explain the problem. Tech Support will tell you where the nearest factory-authorized service center is located in your area.

Appendix E : Glossary Of Terms

The glossary contains brief definitions of many of the audio and electronic terms and acronyms used in discussions of sound mixing and recording. If you would like more information, we recommend the following:

The Audio Dictionary — Glenn White

Tech Terms — Peterson & Oppenheimer

Handbook For Sound Engineers — Glen Ballou

One Louder Magazine — Troy Monteforte

Pro Audio Reference — Dennis Bohn

Sound Reinforcement Handbook — Gary Davis

A/D Converter — Analog-to-digital converter. A device that transforms incoming analog signals into digital form.

AFL — An acronym for After Fade Listen, which is another way of saying post-fader solo function.

Attenuate — To reduce or make quieter.

Aux — Short for auxiliary.

Auxiliary — Long for aux. In sound mixers, supplemental equipment or features that provide additional capabilities to the basic system.

Aux Send — A mixer bus output designed to send a signal to an auxiliary processor or monitor system.

Balanced Input — An input consists of two leads, neither of which is common to the circuit ground. This is a "differential pair", where the signal consists of the *difference* in voltage between the two leads. Balanced input circuits can offer excellent rejection of common-mode noise induced into the line.

Balanced Output — In a classic balanced audio circuit, the output is carried on two leads (high or + and low or -) which are isolated from the circuit ground by exactly the same impedance.

A symmetrical balanced output carries the same signal at exactly the same level but of opposite polarity with respect to ground.

A special case of a balanced output carries the signal on only one lead, with the other lead being at zero voltage with respect to ground, but at the same impedance as the signal-carrying lead. This is sometimes called *impedance balanced*.

Bandwidth — The band of frequencies that pass through a device with a loss of less than 3 dB, expressed in Hertz [Hz] or in musical octaves. Also see Q.

Channel — A functional path in an audio circuit: an input channel, an output channel, the iPad channel, an FX channel and so on.

Channel Strip — An audio channel consisting of a long, vertical strip.

Clipping — A form of severe audio distortion that results from peaks of the audio signal attempting to rise above the capabilities of the amplifier circuit. Seen on an oscilloscope, the audio peaks appear clipped off. To avoid clipping, reduce the system gain in or before the gain stage in which the clipping occurs. Also see headroom.

Compressor — This is a dynamic processor used to smooth out any large transient peaks in an audio signal that might otherwise overload your system or cause distortion. The amplitude threshold and other parameters such as attack time, release time, and tire pressure are adjustable.

Glossary Of Terms Continued...

Condenser — Another term for the electronic component generally known as a capacitor. In audio, condenser often refers to a type of microphone that uses a capacitor as the sound pickup element. Condenser microphones require electrical power to run internal amplifiers and maintain an electrical charge on the capacitor. They are typically powered by internal batteries or phantom power supplied by the mixer.

Console — Another term for mixer. DL32R mixer = DL32R console.

D/A Converter — Digital-to-analog converter. A device that transforms incoming digital signals into analog form.

dB — See decibel.

dBu — A unit of measurement of audio signal voltage in an electrical circuit, expressed in decibels referenced to 0.775 VRMS into any impedance. Commonly used to describe signal levels within a modern audio system.

Decibel (dB) — The dB is a ratio of quantities measured in similar terms using a logarithmic scale. Many audio system parameters measure over such a large range of values that the dB is used to simplify the numbers. A ratio of 1000:1 = 60 dB. Since dB is a unitless quantity, it doesn't matter if it's volts or dollars. (Just try asking the chief engineer for a 3 dB raise). When one of the terms in the ratio is an agreed upon standard value, such as 1.23 V, 1 V or 1 mw, the ratio becomes an absolute value. For example, +4 dBu, -10 dBV or 0 dBm.

Delay — Delay "delays" the audio signal for a short period of time. Delay can refer to one short repeat, a series of repeats or the complex interactions of delay used in chorusing or reverb.

Dipping — The opposite of peaking, of course, used in audio to describe the shape of a frequency response curve. A dip in an EQ curve looks like a valley, or a dip. Dipping with an equalizer reduces a range of frequencies. (See guacamole).

Doubling — A delay effect where the original signal is mixed with a medium (20 to 50 ms) delayed copy of itself. When used carefully, this effect can simulate double-tracking [recording a voice or instrument twice].

Dry — Dry means without effects. It is just the signal alone; no reverb, no delay, etc.

DSP — Digital Signal Processing accomplishes the same functions found in analog signal processors, but performs them mathematically in the digital domain, with more precision and accuracy than its analog counterpart. Since DSP is a software-based process, parameters and processing functions are easily changed and updated by revising the Master Fader app.

Dynamic Microphone — The class of microphones that generate electrical signals by the movement of a coil in a magnetic field. Dynamic microphones are rugged, relatively inexpensive, capable of very good performance and do not require external power.

Dynamics Processor — A type of processor that only affects the overall amplitude level of the signal (sometimes as a function of its frequency content), such as a gate, compressor, or limiter.

Dynamic Range — The range between the maximum and minimum sound levels that a sound system can handle. It is usually expressed in decibels as the difference between the level at peak clipping and the level of the noise floor.

Echo — The reflection of sound from a surface such as a wall or floor. Reverberation and echo are terms that are often used interchangeably, but in audio parlance a distinction is usually made: echo is considered to be a distinct, recognizable repetition (or series of repetitions) of a word, note, phrase or sound, whereas reverberation is a diffuse, continuously smooth decay of sound.

Glossary Of Terms Continued...

EIN — Equivalent Input Noise. A specification that helps measure the “quietness” of a gain stage by deriving the equivalent input noise voltage necessary to obtain a given preamp’s output noise. Numerically, it’s the output noise at a given gain setting minus the gain. EIN is usually measured at a maximum gain and typically ranges from -125 to -130 dBu.

EQ — Short for equalization.

EQ Curve — A graph of the response of an equalizer, with frequency on the x (horizontal) axis and amplitude (level) on the y (vertical) axis. Equalizer types and effects are often named after the shape of the graphed response curve, such as peak, dip, bell and shelf.

Equalization — Long for EQ. Equalization refers to purposefully changing the frequency response of a circuit, sometimes to correct for previous unequal response (hence the term, equalization), and more often to boost or cut the level at certain frequencies for sound enhancement, to remove extraneous sounds, or to create completely new and different sounds.

A lot of how we refer to equalization has to do with what a graph of the frequency response looks like. A flat response (no EQ) is a straight line; a peak looks like a hill, a dip is a valley, a notch is a really skinny valley, and a shelf looks like a plateau (or shelf). The slope is the grade of the hill on the graph.

Fader — Another name for an audio level control.

Filter — A simple equalizer designed to remove certain ranges of frequencies. The high-pass filter attenuates frequencies below its cutoff frequency.

FOH — Front Of House. See house and main (house) speakers. No engineer ever goes to the BOH because there’s never enough time to drink beer.

Frequency — The number of times an event repeats itself in a given period of time. Generally, the time period for audio frequencies is one second, and frequency is measured in cycles per second, abbreviated Hz, honoring Dr. Heinrich Hertz (who did not invent the rental car company). One Hz is one cycle per second. One kHz (kilohertz) is 1000 cycles per second.

The audio frequency range is generally considered to be 20 Hz to 20,000 Hz (or 20 kHz). This covers the fundamental pitch and most overtones of musical instruments.

Gain — The measure of how much a circuit amplifies a signal. Gain may be stated as a ratio of input to output voltage, current or power, such as a voltage gain of 4, or a power gain of 1.5, or it may be expressed in decibels, such as a line amplifier with a gain of 10 dB.

Gain Stage — An amplification point in a signal path, either within a system or a single device. Overall system gain is distributed between the various gain stages.

Gate — A dynamics processor that automatically turns off an input signal when it drops below a certain level. This can reduce the overall noise level of your mix by turning off inputs when they are not in use. Threshold, attack time, hold, and release time are some of the adjustable gate parameters.

Graphic EQ — The graphic equalizer uses sliders for its boost / cut controls, with its operating frequencies evenly spaced through the audio spectrum. In a perfect world, a line drawn through the centers of the control shafts would form a graph of the frequency response curve. Or, the positions of the sliders give a graphic representation of boost or cut levels across the frequency spectrum.

Glossary Of Terms Continued...

Ground — Also called earth. Ground is defined as the point of zero voltage in a circuit or system, the reference point from which all other voltages are measured.

In electrical power systems, ground connections are used for safety purposes, to keep equipment chassis and controls at zero voltage and to provide a safe path for errant currents. This is called a *safety ground*. Maintaining a good safety ground is essential to preventing electrical shock. Follow manufacturer's suggestions and good electrical practices to ensure a safely grounded system. Never remove or disable the grounding pin on the power cord.

In sensitive electronic equipment, tiny currents and voltages riding on the ground (so it's not truly zero volts) can cause noise in the circuits and hamper operation. Often a ground separate from the power ground is used as the reference point for the electronics, isolating the sensitive electronics from the dirty power ground. This is called a *technical ground*.

Quality audio equipment is designed to maintain a good technical ground and also operate safely with a good safety ground.

Ground Loop — A ground loop occurs when the technical ground within an audio system is connected to the safety ground at more than one place. This forms a loop around which unwanted current flows, causing noise in the audio system. Never disable the safety ground in an attempt to solve hum problems.

Guacamole — A delicious dip comprised mostly of avocados. Speaking of dips, refer to dipping.

Hertz — The unit of frequency, equal to 1 cycle per second. 1000 Hz equals 1 kHz.

House — In audio-land, the house refers to the systems (and even persons) responsible for the primary sound reinforcement in a given venue. Hence, we have the house mixer or house engineer, the house mix, house mix amps, main house speakers, etc.

Hz — Short for Hertz.

Impedance — The A.C. resistance, capacitance, and inductance in an electrical circuit, measured in ohms [Ω]. In audio circuits (and other AC circuits) the impedance in ohms may often be much different from the circuit resistance as measured by a DC ohmmeter.

Maintaining proper circuit impedance relationships is important to avoid distortion and minimize added noise. Our input and output impedances are set to work well with the vast majority of audio equipment.

Knee — A knee is a sharp bend in a compressor gain curve, not unlike a sharp bend in your leg.

Level — Another word for signal, voltage, power, strength or volume. Audio signals are sometimes classified according to their level. Commonly used levels are: microphone level (–40 dBu or lower), instrument level (–20 to –10 dBu), and line level (–10 to +30 dBu).

Line Level — A signal whose level falls between –10 dBu and +30 dBu.

Main (House) Speakers — The main loudspeakers for a sound reinforcement system. These are usually the largest and loudest loudspeakers, positioned facing the audience; the sound is typically delivered from the stage. This is also called the PA.

Mains — Short for *main* or *house* speakers in a sound reinforcement system.

Master — Me. I am your master. Obey! The master on the Master Fader app, though, refers to the master fader. It affects the total level of the selected output in which one or more signals are mixed together.

Glossary Of Terms Continued...

Mic Amp — See *Mic Preamp*.

Mic Level — The typical level of a signal from a microphone. A mic level signal (usually – but not always – coming from a microphone) is generally lower than –30 dBu. With a very quiet source [a pin dropping?] the signal may be –70 dBu or lower.

Some microphones, notably vintage or vintage-style condenser mics, deliver a higher signal level than this for the same sound pressure level. A “hot” mic output level isn’t necessarily a measure of the microphone’s quality; it’s just an option that the designer(s) chose.

Mic Pre — Short for *Mic Preamp*.

Mic Preamp — Short for microphone preamplifier. An amplifier whose job is to bring the very low microphone level signal up to line level, or in the case of a mic preamp built into a mixer, the mixer’s internal operating level [approximately 0 dBu].

Mic preamps often have their own volume control, called gain, to properly set the gain for a particular source. Setting the mic preamp gain correctly is an essential step in establishing good signal-to-noise ratio and sufficient headroom. The DL Series mixers are outfitted with Onyx mic preamps.

Mixer — An electronic device used to combine various audio signals into a common output. Different from a blender, which combines various fruits and alcohol into a common libation.

Monaural — Long for mono. Literally, pertaining to or having the use of only one ear.

In the audio field, monaural describes a signal or system which carries audio information on a single channel with the intent of reproducing it from a single source. One microphone is a mono source; many microphones mixed to one channel is a mono mix; a stereo (or – to be picky – a two-channel) mix of many microphones panned left and right is a stereo mix of mono sources.

Monaural listening, and therefore mono compatibility of a stereo mix, is more important than you might realize. Most people hear television audio and clock radios in mono.

Monitor — In sound reinforcement, monitor speakers [or monitor headphones or in-ear monitors] are used by performers to hear themselves. In the video and broadcast world, monitor speakers are often called foldback speakers. In recording, the monitors speakers are those used by the engineer and production staff to listen to the recording as it progresses. In zoology, the monitor lizard is the lizard that observes the production staff as the recording progresses. Keep the lizard out of the mixer.

Mono — Short for *monaural* (and mononucleosis for that matter).

Mute Groups — Mute groups allow you to quickly mute (and unmute) multiple channels and/or outputs with a single tap. There are a multitude of possibilities in which to assign and enable mute groups: productions featuring a rotating cast of musicians, theater productions, a house of worship and more. It is also great for muting all inputs during song breaks or in-between sets. You may create as many as four separate mute groups with Master Fader.

Noise — Whatever you don’t want to hear. This could be hum, buzz or hiss; or it could be crosstalk, digital hash, or your neighbor’s stereo; or it could be white noise, pink noise or brown noise. It’s also how your parents describe your band. After all, it’s what *they* don’t want to hear.

Noise Floor — The residual level of noise in any system. In a well-designed mixer (such as the DL Series mixers), the noise floor will be a quiet hiss, which is the thermal noise generated by electrons bouncing around in resistors and semiconductor junctions. The lower the noise floor and the higher the headroom, the more usable dynamic range a system has.

Glossary Of Terms Continued...

Nyquist Sampling Theorem — This theorem states that, when an analog signal is converted to a digital signal, it must be sampled at a frequency that is at least twice the highest audio frequency present in the analog signal. If the audio frequency should exceed one-half the sampling frequency, aliasing may result. Thus, if an analog-to-digital converter is sampling at 44.1 kHz, the audio signal should not exceed 22.05 kHz.

PA — Acronym for Public Address. Today, people who work with PA systems like to say they're working in "sound reinforcement". See SR.

Pan — Pan sliders are used to position (or even dynamically move) a monaural sound source in a stereo mixing field by adjusting the source's volume between the left and right channels. Our brains sense stereo position by hearing this difference in loudness when the sound strikes each ear, taking into account time delay, spectrum, ambient reverberation and other cues.

Peaking — The opposite of dipping. A peak is an EQ curve that looks like a hill, or a peak. Peaking with an equalizer amplifies a band of frequencies.

PFL — An acronym for Pre-Fade Listen. Broadcasters call it cueing. Sound folks call it being able to solo a channel with the fader down.

Phantom Power — A system of providing electrical power for condenser microphones (and some electronic pickup devices) from the microphone input jack. The system is called phantom because the power is carried on a standard microphone audio wiring in a way that is "invisible" to ordinary dynamic microphones. The DL Series mixers use a standard +48 volt DC power, switchable on or off.

Generally, phantom power is safe to use with non-condenser microphones, as well, especially dynamic microphones. However, unbalanced microphones, some electronic equipment (such as some wireless microphone receivers) and some ribbon microphones can short out the phantom power and be severely damaged.

Phase — The time relationship between two signals, expressed in degrees around a circle. 0° and 360° represent an in-phase relationship. Both signals change in the same way at the same time. Anything else is out of phase.

180° out-of-phase is a special case which, for a continuous waveform, means that at any given time the two signals have the same amplitude but are opposite in polarity. The two legs of a differential output are 180° out-of-phase. The polarity invert button (found in the EQ view) reverses the signal polarity.

When out-of-phase signals are mixed, there will be some cancellation at certain frequencies, the frequencies and the degree of cancellation being a function of the amount of phase shift and the relative amplitude of the signals. Attention to mic placement and careful listening will allow you to use this effect creatively.

Post Fader — A term used to describe an aux send (or other output) that is connected so that it is affected by the setting of the associated channel fader. Sends connected this way are typically (but not always) used for effects. A post-fader output from a mixer channel is usually post-EQ.

Pre DSP — Pre DSP is ideal when using the auxes for monitor mixes and you want compression and other effects in the main mix, but not the monitors. Pre DSP is available in all auxes, but not the FX.

Pre Fader — A term used to describe an aux send (or other output) that is connected so that it is not affected by the setting of the associated channel fader. Sends connected this way are typically (but not always) used for monitors.

Q — A way of stating the bandwidth of a filter or equalizer section. An EQ with a Q of .75 is broad and smooth, while a Q of 10 gives a narrow, pointed response curve. To calculate the value of Q, you must know the center frequency of the EQ section and the frequencies at which the upper and lower skirts fall 3 dB below the level of the center frequency. Q equals the center frequency divided by the difference between the upper and lower 3 dB-down frequencies. A peaking EQ centered at 10 kHz whose -3 dB points are 7.5 kHz and 12.5 kHz has a Q of 2.

Glossary Of Terms Continued...

Reverberation, Reverb — The sound remaining in a room after the source of sound is stopped. It's what you hear in a large tiled room immediately after you've clapped your hands.

Reverberation and echo are terms that are often used interchangeably, but in audio parlance, a distinction is usually made: reverberation is considered to be a diffuse, continuously smooth decay of sound, whereas echo is one or more distinct, recognizable repetitions of a word, note, phrase or sound which decreases in amplitude with every repeat.

Highly reverberant rooms are called live; rooms with very little reverberation are called dead. A sound source without added reverb is dry; one with reverb added is wet.

RFI — Radio Frequency Interference. High frequency radiation that often results from sparking circuits. This may be manifested in a number of ways in audio systems, but is usually evident as a high-frequency buzz or harsh sound.

RMS — An acronym for root mean square, a conventional way to measure the effective average value of an audio signal or other AC voltage. Most AC voltmeters are calibrated to read RMS volts, though on many meters that calibration is accurate only if the waveform is sinusoidal.

Sampling Frequency — This is the rate at which an analog signal is sampled during the analog-to-digital conversion process. The sampling rate used for CDs is 44.1 kHz, but professional recordings are often sampled at higher sample rates.

Send — A term used to describe the output of a secondary mix of the input signals, typically used for monitors, headphone amp or effects devices. These are the aux sends on the DL Series mixers.

Shelving — A term used to describe the shape of an equalizer's frequency response. A shelving equalizer's response begins to rise (or fall) at some frequency and continues to rise (or fall) until it reaches the shelf frequency, at which point the response curve flattens out and remains flat to the limits of audibility. If you were to graph the response, it would look like a shelf. Or more like a shelf than a hiking boot. See also peaking and dipping.

Signal-to-Noise (S/N) — This is a specification that describes how much noise an audio component has compared to the signal. It is usually expressed in dB below a given output level. The S/N of the DL Series mixers is 92 dB.

Solo — Italian for alone. Solo allows you to listen to individual channels singly or in combination with other soloed signals.

Sound Reinforcement — A system of amplifying acoustic and electronic sounds from a performance or speech so that a large audience can hear clearly. Or, in popular music, so that a (hopefully) large audience can be excited, stunned, or even partially deafened by the tremendous amplification. Sound reinforcement means essentially the same thing as PA [Public Address].

Spaghetti — That mess of wires and cables in the back of your rack and/or console. You really can tame this beast.

SR — An acronym for Sound Reinforcement, which refers to the process (or a system for) amplifying acoustic and electronic sounds from a performance or speech so that a large audience can hear clearly. Or, in popular music, so that a (hopefully) large audience can be excited, stunned, or even partially deafened by the tremendous amplification. Sound reinforcement means essentially the same thing as PA [Public Address].

Glossary Of Terms Continued...

Stereo — Believe it or not, stereo comes from a Greek word that means solid. We use stereo or stereophony to describe the illusion of a continuous, spacious sound field that is seemingly spread around the listener by two or more related audio signals. In practice, stereo often is taken to simply mean two channels.

Tinnitus — The ringing in the ears that often results from prolonged exposure to very loud sound levels.

TRS — Acronym for Tip-Ring-Sleeve, the three parts of a two conductor (plus shield) phone plug. Since the plug or jack can carry two signals and a common ground, TRS connectors are often referred to as stereo or balanced plugs or jacks.

TS — Acronym for Tip-Sleeve, the two parts of a single conductor (plus shield) phone plug. TS connectors are sometimes called mono or unbalanced plugs or jacks. A ¼" TS phone plug or jack is also called a standard phone plug or jack.

Unbalanced — An electrical circuit in which the two legs of the circuit do not have the identical impedance to ground. Often one leg is also at ground potential. Unbalanced circuit connections require only two conductors (signal "hot" and ground). Unbalanced audio circuitry is less expensive to build, but under certain circumstances is more susceptible to noise pickup.

View Groups — View groups allow you to see only the channels that you want to view, hiding the rest. This improves organization and allows for faster navigation. You may create and assign as many as four separate view groups with Master Fader.

Volume — The sound level in an audio system. Perhaps the only thing that some bands have too much of.

VRMS — Acronym for Volts Root Mean Square. See *RMS*.

Wet — A signal with added reverberation or other effect like echo, delay or chorusing.

XLR Connector — Three-pin connectors now universally used for balanced microphone connections. Also known as Cannon, as Cannon was the original manufacturer of this type of connector. In sound work, a Cannon connector is taken to mean a Cannon XLR-3 connector or any compatible connector. You can tell who the audio geezers are when they refer to XLR connectors as Cannon connectors.

Z — The electrical symbol for *impedance*.

Zymurgy — The science of brewing, an important part of our technology and history since we are located less than one mile from the Red Hook brewery. Besides, we need something other than just a plain 'ol "Z" to end the glossary.

Warranty Statement

Please keep your sales receipt in a safe place.

This Limited Product Warranty ("Product Warranty") is provided by LOUD Technologies Inc. ("LOUD") and is applicable to products purchased in the United States or Canada through a LOUD-authorized reseller or dealer. The Product Warranty will not extend to anyone other than the original purchaser of the product (hereinafter, "Customer," "you" or "your").

For products purchased outside the U.S. or Canada, please visit www.mackie.com/warranty to find contact information for your local distributor, and information on any warranty coverage provided by the distributor in your local market.

LOUD warrants to Customer that the product will be free from defects in materials and workmanship under normal use during the Warranty Period. If the product fails to conform to the warranty then LOUD or its authorized service representative will at its option, either repair or replace any such nonconforming product, provided that Customer gives notice of the noncompliance within the Warranty Period to the Company at: www.mackie.com/support or by calling LOUD technical support at 1.800.898.3211 (toll-free in the U.S. and Canada) during normal business hours Pacific Time, excluding weekends or LOUD holidays. Please retain the original dated sales receipt as evidence of the date of purchase. You will need it to obtain any warranty service.

For full terms and conditions, as well as the specific duration of the Warranty for this product, please visit www.mackie.com/warranty.

The Product Warranty, together with your invoice or receipt, and the terms and conditions located at www.mackie.com/warranty constitutes the entire agreement, and supersedes any and all prior agreements between LOUD and Customer related to the subject matter hereof. No amendment, modification or waiver of any of the provisions of this Product Warranty will be valid unless set forth in a written instrument signed by the party to be bound thereby.

GPL Statement

This product includes software code developed by third parties, including software code subject to the GNU General Public License ("GPL") Version 2. Where such specific license terms entitle you to the source code of such software, LOUD Technologies Inc. will provide upon written request via email or traditional paper mail the applicable GPL source code files via CD-ROM for a nominal cost to cover media, shipping and handling charges as allowed under the GPL.

The GPL code used in this product is distributed WITHOUT ANY WARRANTY and is subject to the copyrights of one or more authors. For details, see the GPL code and the terms of the GPL. For a copy of the GPL please write to the Free Software Foundation, Inc., 51 Franklin Street, Fifth Floor, Boston, MA 02110-1301, USA.

Please direct all GPL Source Requests to the following email/address.

Attn: GPL Source Request
LOUD Technologies Inc.
16220 Woodinville-Redmond Rd. N.E.
Woodinville, WA 98072

or

techmail@loudtechinc.com



MACKIE®

16220 Wood-Red Road NE • Woodinville, WA 98072 • USA
Phone: 425.487.4333 • Toll-free: 800.898.3211
Fax: 425.487.4337 • www.mackie.com